

A

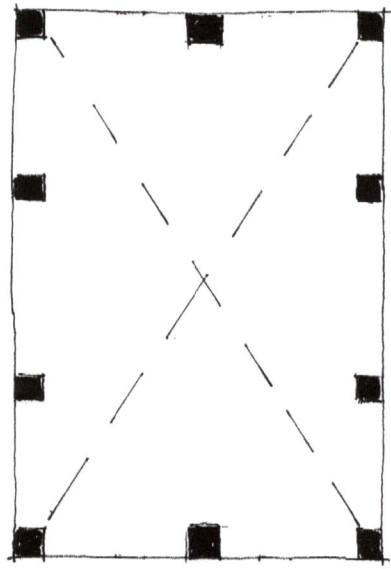

B

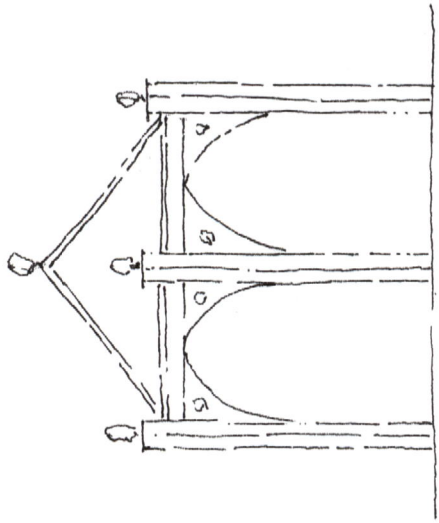
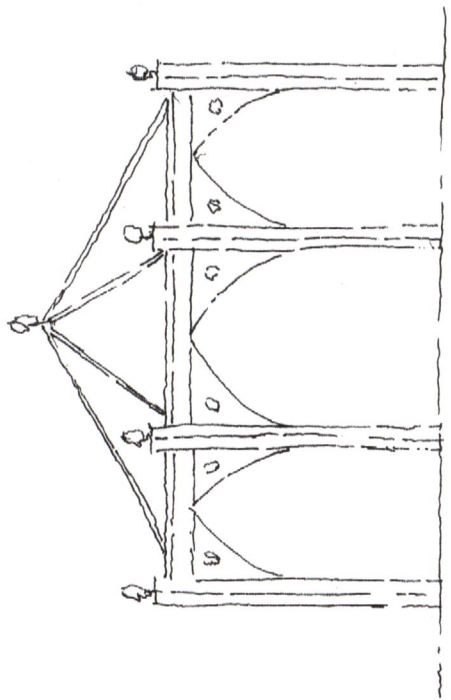
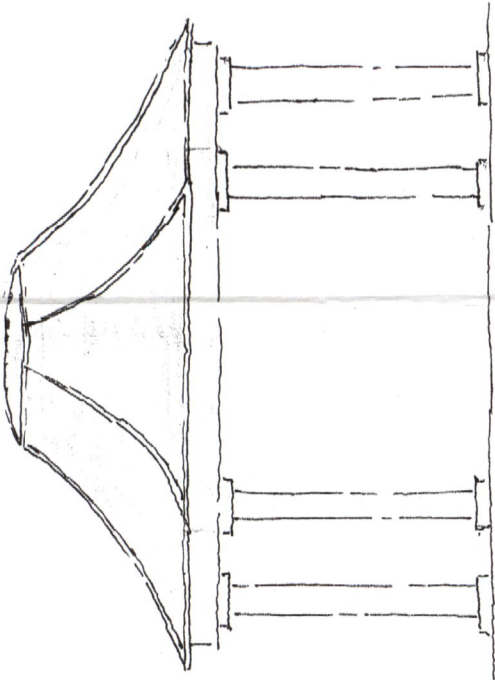

Front elevation

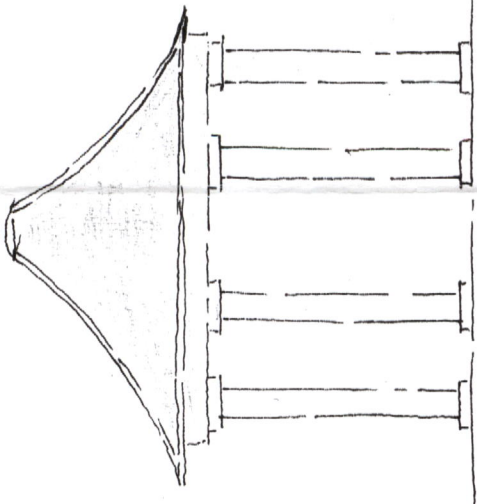

Side elevation

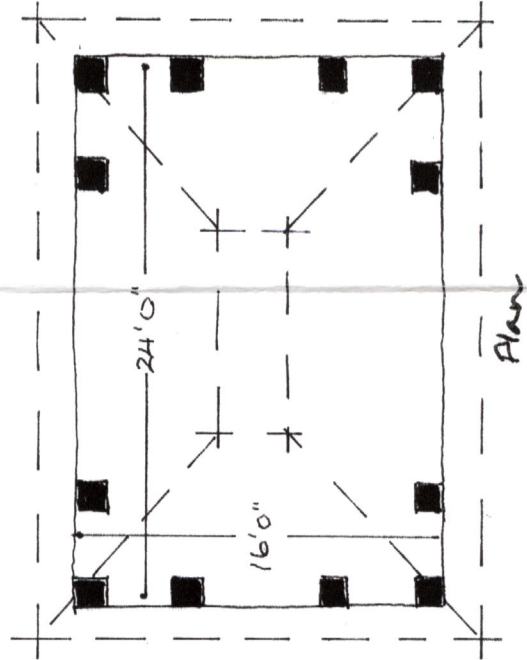

Plan

C

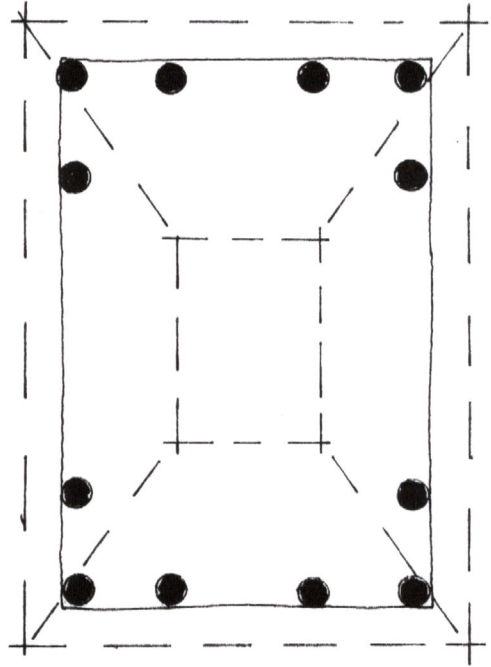
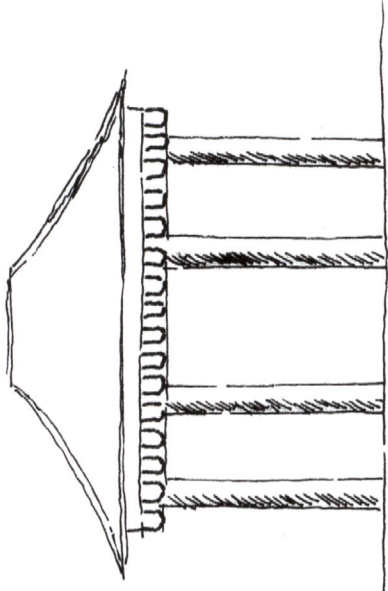
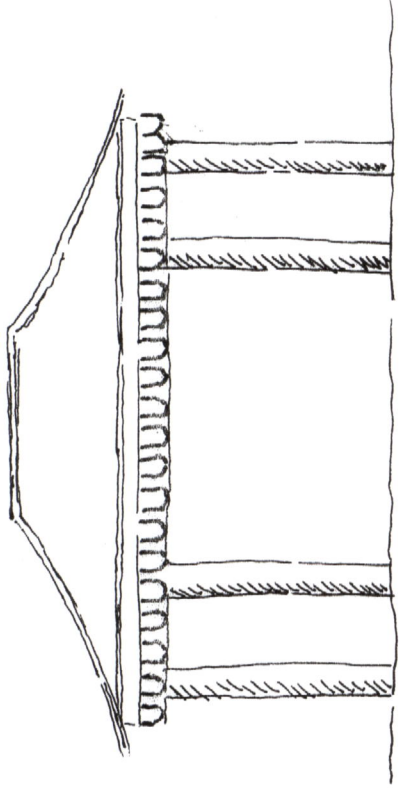

# GARDEN PAVILIONS

Martin Lane Fox FRICS VMH  
Scale 1:100 Approx 21.03.07