SHERWAY CENTRE

Development in the Sherway Centre area will be consistent with the following urban design guidelines. The guidelines correspond to Site Specific Policy #19, in Chapter 7 of the Official Plan. They are to be read in conjunction with the urban design policies of the Official Plan.

LOCATION

Sherway Centre is located immediately west of Highway 427, and north of the Queen Elizabeth Way, north to the CP Rail line and west to the Etobicoke Creek.

GUIDELINES

In order to ensure a comprehensive approach and to address critical urban design issues covered in these guidelines, the City will review developments and require that applicants for individual parcels 'fill in' the surrounding context to their sites. Specifically, applications will address with appropriate documentation to support and address the issues contained in these guidelines.

Public Realm

- A new public road network will be established by either using or extending existing roads, private driveways or service lanes.
- A realigned ring road will be created on the Sherway Gardens site as a public street with generous and distinctive amenities of the highest civic standard.
- Extensions to the existing road system, both regional (ramp additions) and local (new streets with major intersections along The West Mall and The Queensway) will be developed as part of a hierarchical framework of open-ended landscaped streets, lanes and paths.
- On-street parking will be encouraged and incorporated into the design of streets where appropriate, particularly for local roads adjacent to residential or mixed-use developments.
- The interior circulation system of the Sherway Gardens Mall will be extended, linking with the new local road system and public transit.

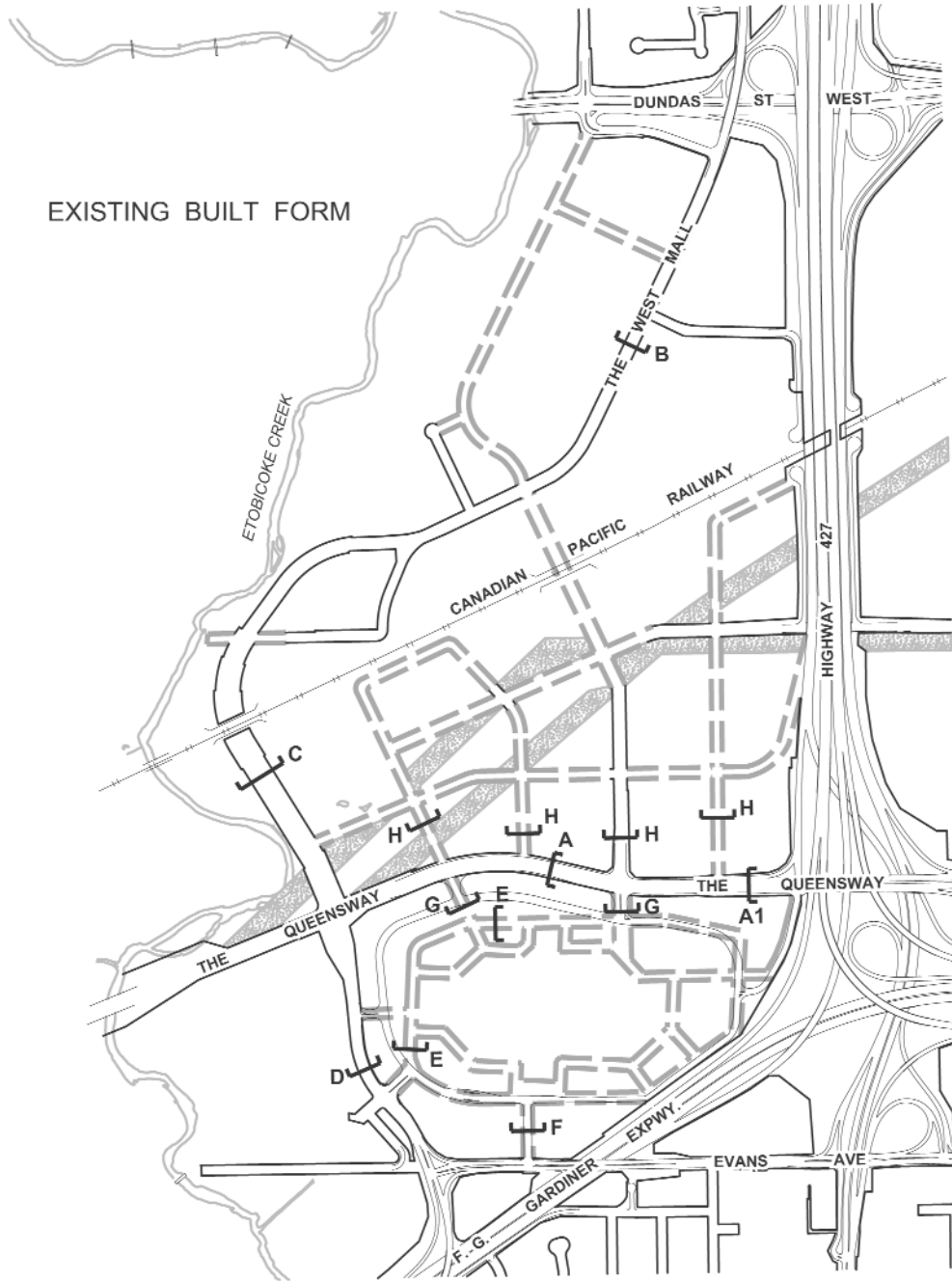

SHERWAY CENTRE

EXISTING BUILT FORM



Sherway Centre - Key to Street Types

MAP A

-  Existing Road
-  Proposed Road
-  Hydro Easement



Not to Scale
04 03

THE QUEENSWAY (STREET SECTION A)

The Queensway will be the major landscaped boulevard in a reurbanized centre and garden district. The public realm will be defined by continuous built form of sufficient height and mass to define the urban space. The height, mass and siting of buildings along The Queensway will be controlled to create a deliberate street wall condition containing and defining the proposed urban space.

Streetscape

- Traffic speed will be slowed with additional intersections and more access points for pedestrians to cross the street.
- Both sides of The Queensway will be extensively landscaped with double rows of deciduous trees.
- The centre median will also be planted with a continuous single row of deciduous trees, allowing for the adjustments for left turn and right turn tapers and storage lanes.
- A dedicated bike lane will be created on both sides of the street adjacent to a landscaped strip.

Built Form:

- A 'build-to' line will be established 15m from the curb edge.
- To maintain the 'street line' continuity, all new buildings on both sides of the road will build within their parcel to a minimum 80% of their building face to the 'build-to' line, as indicated in the cross section diagram.
- A maximum height of 22.5m will be established.
- For heights above 22.5m, a 3.0m setback will be established, with a maximum building height of 30.0m allowed from the setback point.
- Buildings will be permitted to have projections such as balconies, bay windows, and sun rooms, occupying up to 35% of the 2m Discretionary Building Zone, which is in front of the 'build-to' (see street section A).

- Cross section drawing A(1) indicates provision for landmark buildings along The Queensway. These will be located at the junction of Highway 427 and The Queensway and at the intersection of The West Mall and The Queensway.
- Landmark buildings will be allowed. However, the City will determine appropriate heights for individual applications subject to proper planning and engineering studies.
- Landmark buildings will include lower base buildings as a mediating device between the height of the tower and the scale of the street. The towers will be appropriately set back as indicated on Figure A with a 4.5 minimum windshelf.

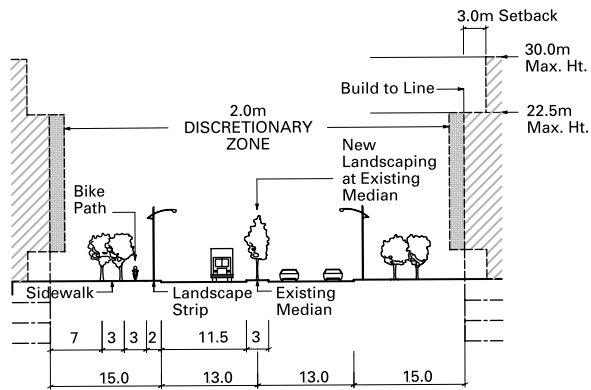

STREET SECTION 'A'

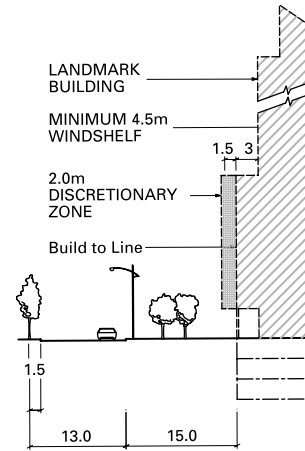

STREET SECTION 'A (II)'
LANDMARK BUILDING

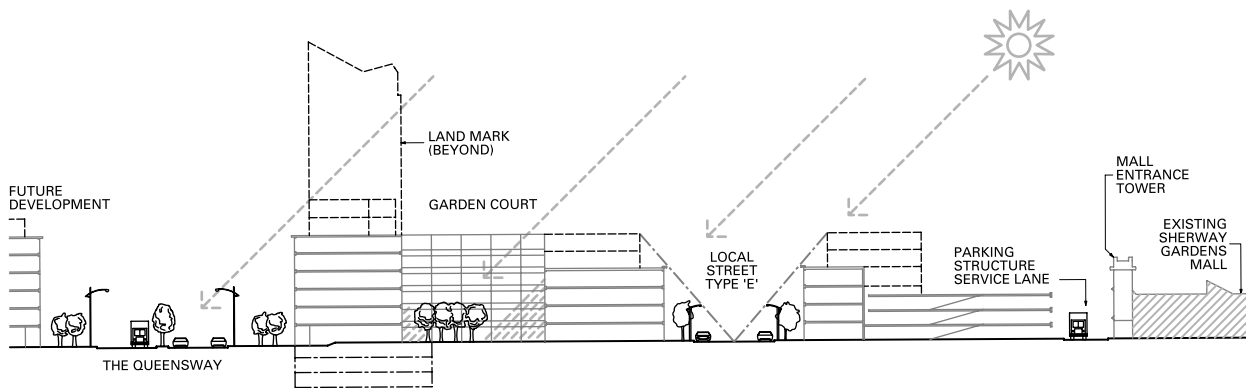

NORTH / SOUTH DEMONSTRATION SECTION

Sherway Centre - Street Section A - The Queensway

FIGURE A

Not to Scale
04-03

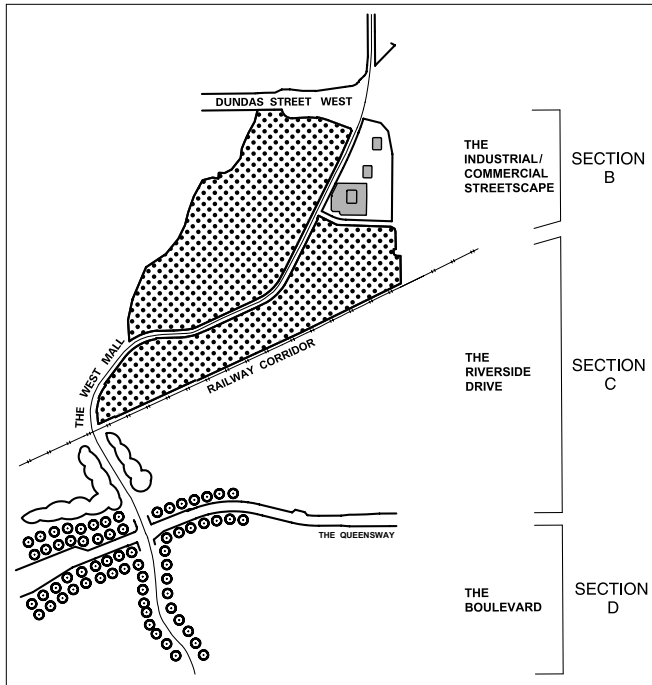

Sherway Centre – Key Map – Street Sections B, C, D

THE WEST MALL (SECTIONS B,C,D)

Built form along The West Mall will respond to the differing conditions of topography and buildings along its length.

The guidelines for built form on any block or individual parcel of land fronting onto The West Mall establish complementary built form conditions to the indigenous qualities of the particular section of The West Mall.

Streetscape:

- Street Condition B: The sidewalk on both sides of the street will be landscaped with a continuous single row of deciduous trees.
- Street Condition C: The sidewalk on both sides of the street will be landscaped with a continuous single row of deciduous trees.
- The centre median will be planted with a continuous single row of deciduous trees.
- Public street amenities including transit shelters, lighting, signage, public art, seating and kiosks, will be incorporated where appropriate into overall boulevard design.

There will be additional street intersections to The West Mall from the newly created local street pattern to facilitate better traffic flow, and integrate the public realm with the interior blocks.

Built Form:

Condition B: Industrial/Commercial Streetscape from south of Dundas Street West to the rail underpass (Section B):

- To maintain 'street-line' continuity, all new buildings on both sides of the road will build, within their parcel, to a minimum 70% of their building face to the build-to line as indicated in the cross section diagram.
- A 45 degree angular plane, taken from the curb line, will be used to establish the maximum building height.

Condition C: The Riverside Drive from the rail underpass to The Queensway (Section C):

- To maintain the integrity of the landscape and qualities of a 'riverside drive', views to the river will be promoted.

SHERWAY CENTRE

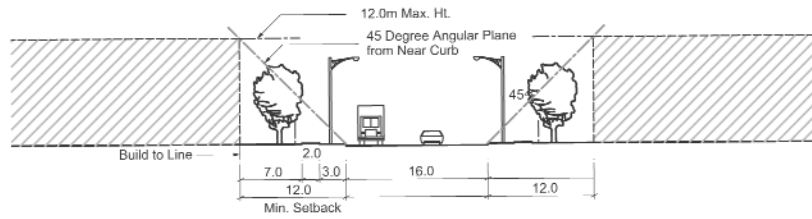

STREET SECTION 'B' - INDUSTRIAL / COMMERCIAL

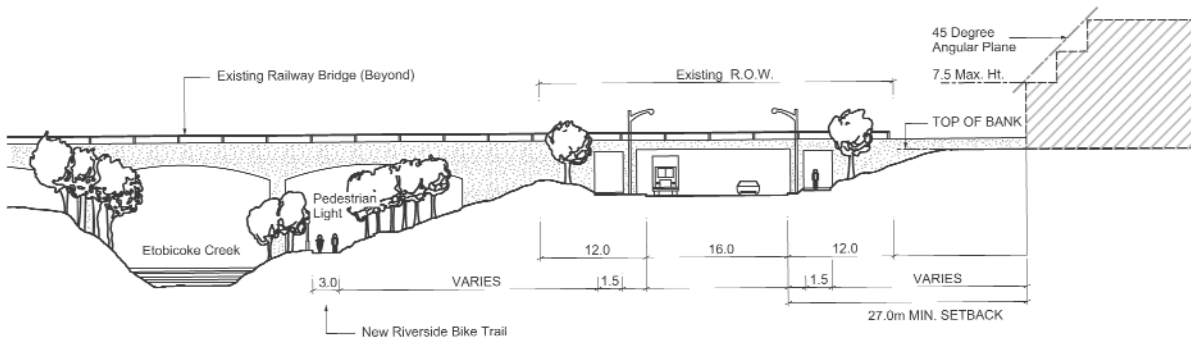

STREET SECTION 'C' - RIVERSIDE DRIVE

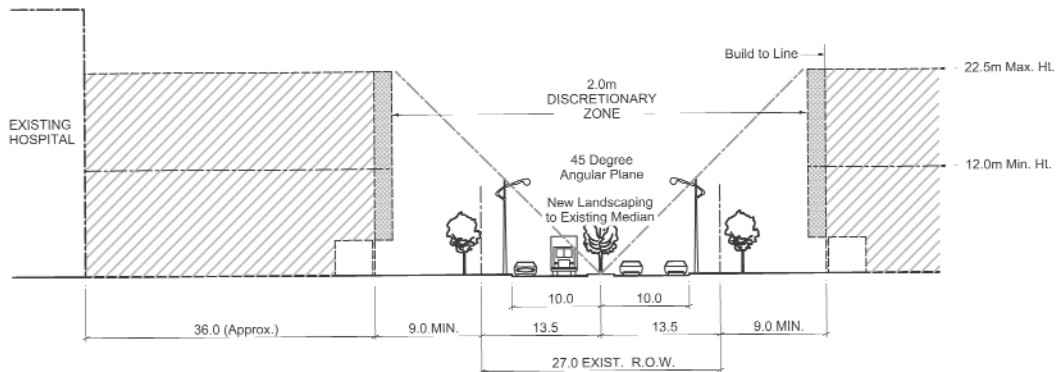

STREET SECTION 'D' - THE BOULEVARD

Sherway Centre - The West Mall - Street Sections B, C, D

Not to Scale
04-03

SHERWAY CENTRE

- Developments will incorporate terraced designs to complement the existing topography.
- The cross section diagram indicates a building setback line of 27.0m and a maximum permissible building height of 7.5m at the 'build-to' line.
- A 45 degree angular plane from the point of maximum building height will be used to establish the allowable terracing condition. The northeast corner site will be guided by The Queensway Guidelines.

Condition D: The Boulevard,. from The Queensway south to the Q.E.W. (Section D):

- A 45 degree angular plane will be used to establish the maximum building height of 22.5m on the east side.
- Buildings will be permitted to have projections such as balconies, windows, and sun rooms, occupying up to 35% of the 2m Discretionary Building Zone.
- Any new development on the east side of The West Mall opposite The Queensway Hospital will be encouraged to define both the street edge and a contained open space (park, playfield, etc.), which would link into the other open spaces of this gardens district.
- The site south of The Queensway Hospital could have a landmark building. Buildings within this site will be terraced in design and complement the ravine condition.
- See Map B—Proposed Built Form

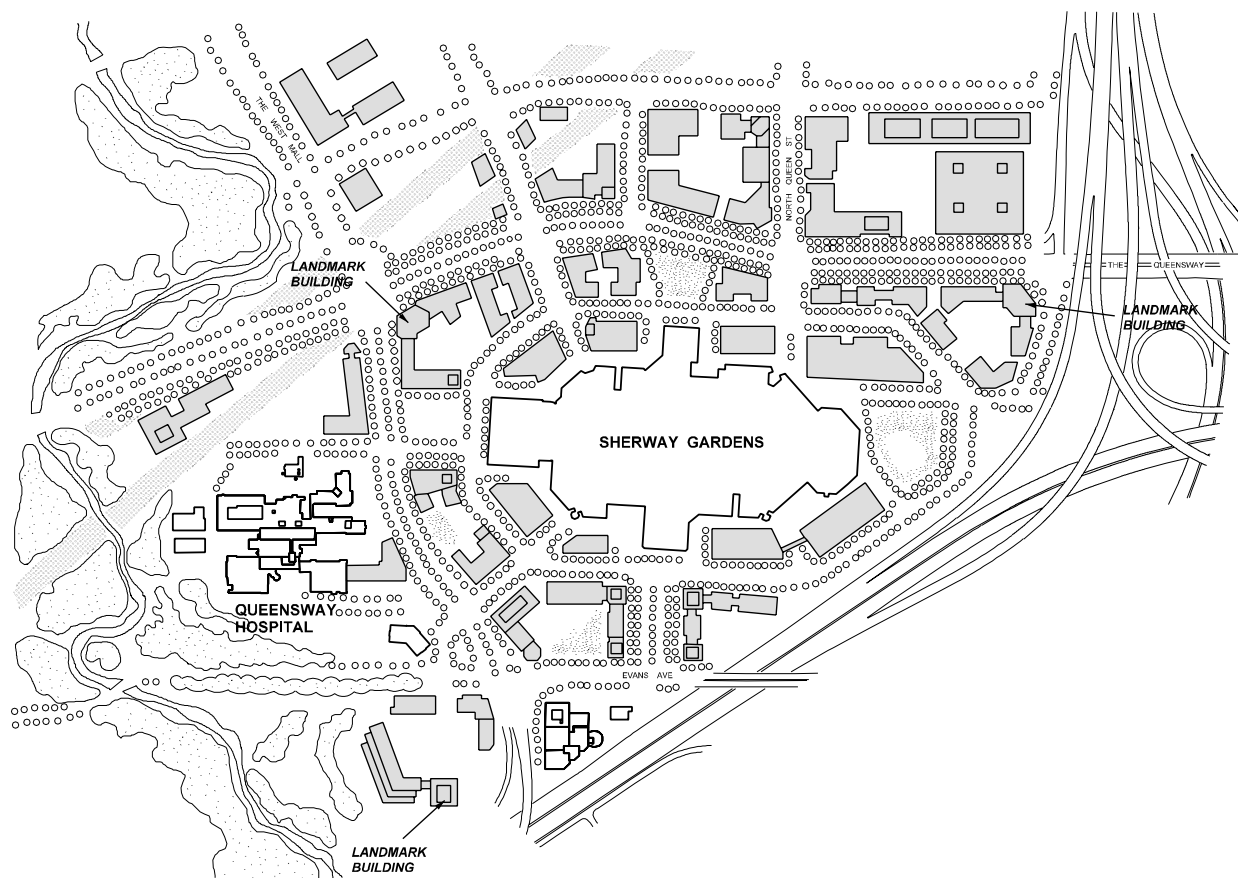

Proposed Built Form

MAP B



Not to Scale
04-03

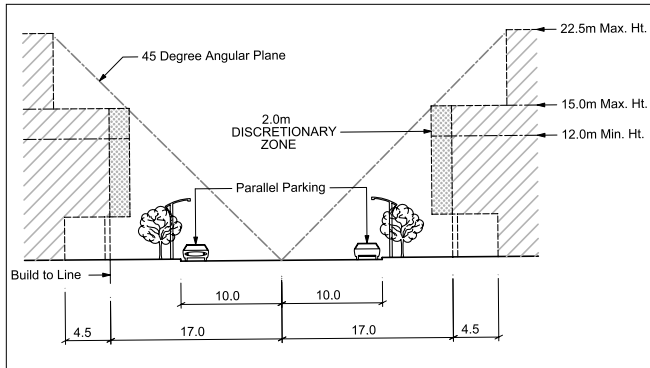

Local Road Network - Street Type "E" - Ring Road

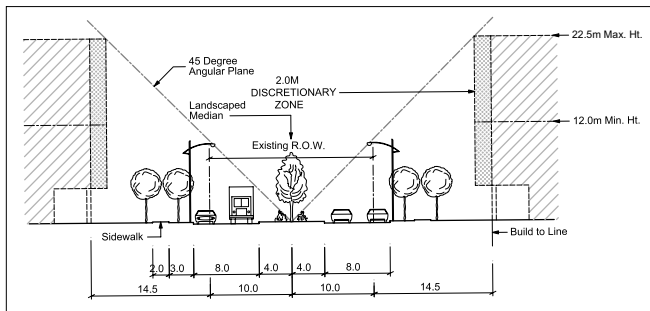

Local Road Network - Street Type "F" - Access Boulevard

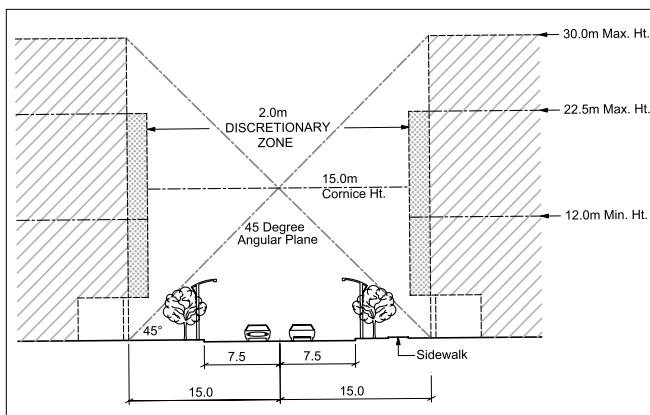

Local Road Network - Street Type "G" - Access Road

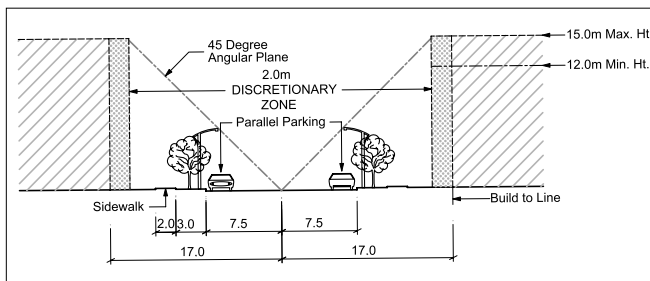

Local Road Network - Street Type "H"

THE LOCAL ROAD NETWORK (SECTIONS E,F,G,H)

A new network of public local roads for cars and pedestrians will be established on both sides of The Queensway to create a coherent, interconnected and viable framework for future incremental development.

The intensification of the Sherway Centre will produce a transition in building height and mass from the highest points at The Queensway, decreasing to the north and south, to a new, more evenly distributed building fabric, created within the framework of an expanded local road network.

Streetscape:

Street Type E - The Ring Road

- The sidewalk will be landscaped on both sides with a single continuous row of deciduous trees.
- On-street parking particularly on the Ring Road will be provided.

Street Type F - The South Access Boulevard to Sherway Gardens

- The sidewalk will be landscaped on both sides with a double continuous row of deciduous trees.
- The centre median will be landscaped with a single continuous row of deciduous trees.

Street Type G and Type H - The Access Drives

- The sidewalk will be landscaped on both sides with a single continuous row of deciduous trees.

Section H, indicates the option for soft landscaped space between the hard surface sidewalk and the building face.

Built Form

Street Type E - The Ring Road:

- To maintain 'street line' continuity, all new buildings on both sides of the road will build, within their parcel, to a minimum 70% of their building face to the 'build to' line as indicated on Section E.
- A 45 degree angular plane from the centre of the road will be used to establish the maximum building height of 15m with setbacks for additional allowable height.

- Buildings will be permitted to have projections such as balconies, bay windows, and sun rooms occupying up to 35% of the 2m Discretionary Building Zone.
- A 12m minimum building height will be applied. If there is insufficient building programme to meet even the minimum height/minimum building frontage requirements, other methods of achieving the build-to requirement may be accepted (e.g., 'frame' or outline structures, colonnades).
- Building designs will create a zone of additional pedestrian amenity at grade along the sidewalk edge in the form of arcades, canopies, awnings or other building elements.

Street Type F – The South Access Boulevard to Sherway Gardens

- To maintain a boulevard/promenade condition and 'street line' continuity for this very short access street, all new buildings on both sides of the road will build, within their parcel, to a minimum 80% of their building face to the 'build-to' line as indicated on Section F.
- A 45 degree angular plane from the centre of the median will be used to establish the maximum building height of 22.5m.
- A minimum 12m building height will be applied.
- A 2m Discretionary Building Zone similar to Type E will be applied.

Street Type G – The Access Drives.

- To maintain the 'street line' continuity, all new buildings on both sides of the road will build, within their parcel, to a minimum 70% of their building face to the 'build to' line as indicated on Section G.
- A 45 degree angular plane will be established from the base of the 'build to' line to ensure a maximum 1:1 control plane relationship and a maximum height allowance of 30.0m.
- Developments are encouraged to effect a height transition exceeding the angular plane controls by stepping down to lower heights moving in either direction away from The Queensway.
- A 15m continuous cornice height line will be encouraged.

- A 2m Discretionary Building Zone similar to Type E will be applied.

Street Type H

- For 'street line' continuity a condition similar to Type E of 70% will be established.
- A 45 degree angular plane will be used to establish the maximum building height of 15m.
- A minimum building height of 12m will be applied.
- A 2m Discretionary Building Zone similar to Type E will be applied.

PARKING

Parking will be used as a positive, secondary (vs. primary) structuring element for future developments in the area. Parking, whether on surface lots or in structures will be screened, preferably by the building configuration or other attached uses, in order to minimize its negative impacts.

- Front yard parking will not be permitted on any streets in the area.
- Street parking will generally be allowed within the local road network subject to policy restrictions (i.e., times of day, length of stay, transit operations). This will slow traffic and create additional convenience parking.
- Parking structures will be sited where possible, to connect to existing pedestrian links between buildings. Parking structures are significant generators of pedestrian activity and will therefore be located strategically within pedestrian networks. They present valuable opportunities to make important connections by:
 - bridging between the parking structure and other buildings
 - locating grade level entrances at key locations along sidewalks, and tying internal pedestrian circulation to transit locations
- Parking structures will be used as built form to create continuous street frontages which will be lined with publicly accessible uses (e.g. retail, community facilities).

HYDRO CORRIDORS

The Hydro easements will be reclaimed as part of the public realm and park and recreational uses encouraged. Strong connections will be made by means of tree planting, and other landscape measures, to tie together these lands with network of pedestrian open spaces.

The use of the Hydro easement lands for surface parking lots will only be allowed subject to detailed design proposals.

EXISTING

PROPOSED

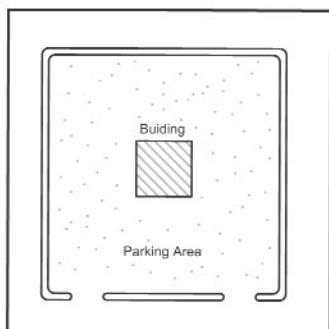

CONVENTIONAL PERIMETER PARKING SUBURBAN MODEL

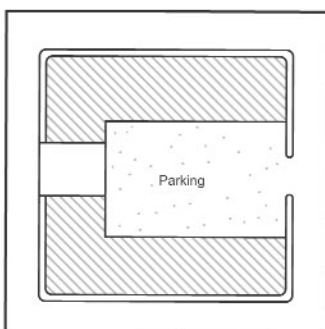

BUILDING USED TO SCREEN PARKING URBAN MODEL

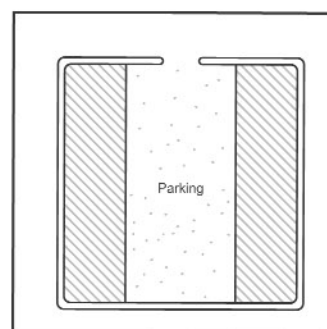

STREET BUILDING WITH PARKING COURT URBAN MODEL

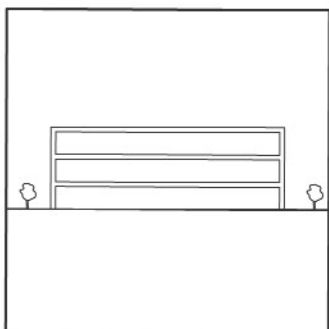

CONVENTIONAL PARKING STRUCTURE

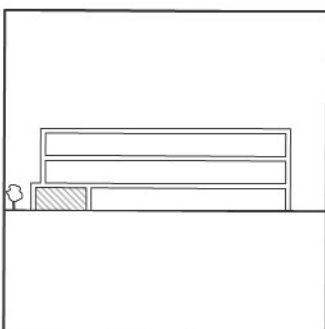

PARKING STRUCTURE WITH STREET RELATED COMMERCIAL USE

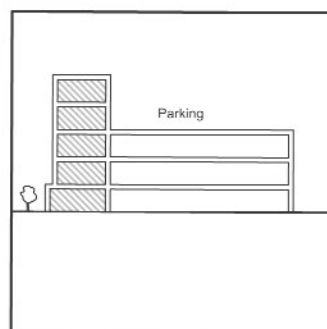

PARKING STRUCTURE WITH STREET FRONTAGE MIXED USE BUILDING

Sherway Centre - Parking Diagrams

Not to Scale
04-03