

Confidential Appendix B
made public on May 4, 2018

PROJECT:

31 PARLIAMENT STREET
TORONTO, CANADA
37 STOREY OPTION

PREPARED FOR:

1150782 ONTARIO INC.

2018.04.12

REVISED SUBMISSION

PREPARED BY:

ARQUITECTONICA

NOTE:

WITHOUT PREJUDICE AND FOR
SETTLEMENT PURPOSES ONLY



ARQUITECTONICA

PREPARED FOR:
1150782 ONTARIO INC.

NOTE: WITHOUT PREJUDICE AND FOR
SETTLEMENT PURPOSES ONLY

PROJECT:
**31 PARLIAMENT STREET
TORONTO, CANADA
37 STOREY OPTION**

DRAWING:
VIEW LOOKING SOUTHWEST

DATE: 4/12/2018 9:42:12 AM



ARQUITECTONICA

PREPARED FOR:
1150782 ONTARIO INC.

NOTE: WITHOUT PREJUDICE AND FOR
SETTLEMENT PURPOSES ONLY

PROJECT:
**31 PARLIAMENT STREET
TORONTO, CANADA
37 STOREY OPTION**

DRAWING:
PEDESTRIAN VIEW LOOKING EAST

DATE: 4/12/2018 9:42:15 AM



ARQUITECTONICA

PREPARED FOR:
1150782 ONTARIO INC.

NOTE: WITHOUT PREJUDICE AND FOR
SETTLEMENT PURPOSES ONLY

PROJECT:
**31 PARLIAMENT STREET
TORONTO, CANADA
37 STOREY OPTION**

DRAWING:
GROUND FLOOR PEDESTRIAN VIEW LOOKING EAST

DATE: 4/12/2018 9:42:16 AM

LEVEL 06 - 12
(PROPOSED)

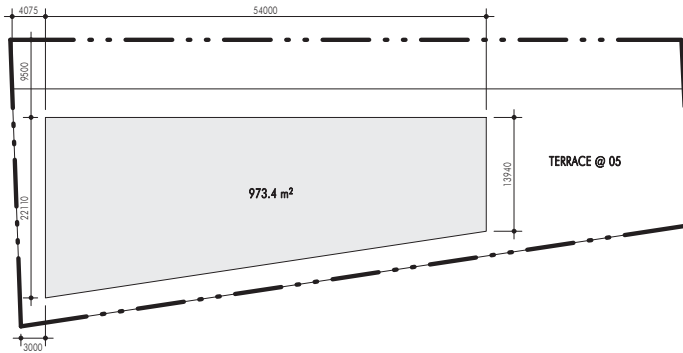

LEVEL 13 - 23
(PROPOSED)

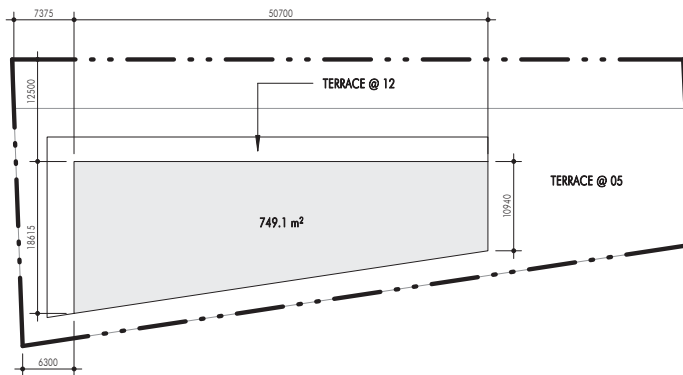

LEVEL 24 - 37
(PROPOSED)

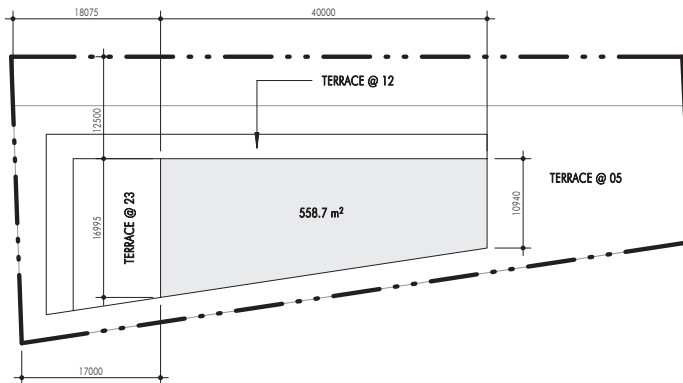

LEVEL 06 - 12
(INSET BALCONY
DIAGRAM)

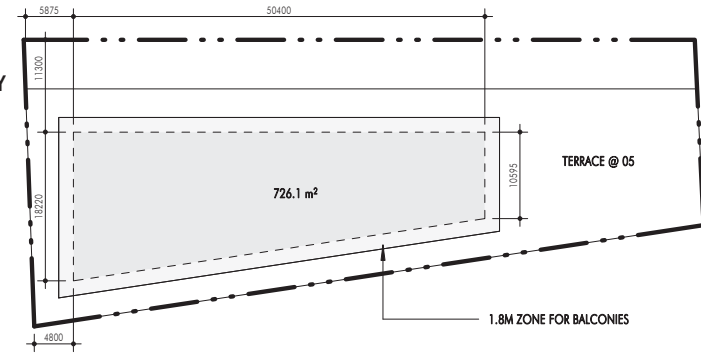

LEVEL 13 - 23
(INSET BALCONY
DIAGRAM)

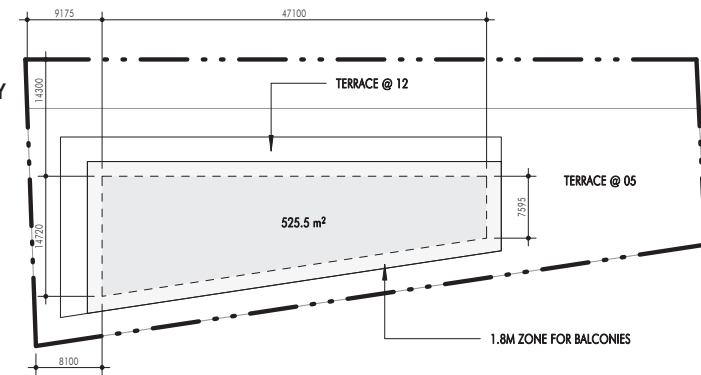

LEVEL 24 - 37
(INSET BALCONY
DIAGRAM)

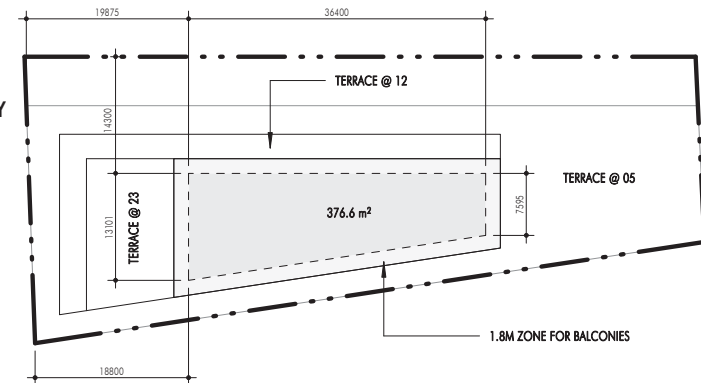

PREPARED FOR:
1150782 ONTARIO INC.
NOTE: WITHOUT PREJUDICE AND FOR
SETTLEMENT PURPOSES ONLY

PROJECT:
**31 PARLIAMENT STREET
TORONTO, CANADA
37 STOREY OPTION**

DRAWING:
INSET BALCONY DIAGRAMS

PROJECT
NORTH
TRUE
NORTH

ARQUITECTONICA
SCALE 1:600
DATE: 4/12/2018 9:42:16 AM

31 PARLIAMENT STREET STATISTICS - 37 STOREY OPTION

Floor	1bd	1bd+den	2bd	2bd+den	3bd	3bd+den	Subtotals	Gross Area
Mech								
37	1	0	4	0	0	0	5	558.7
36	1	0	4	0	0	0	5	558.7
35	1	0	4	0	0	0	5	558.7
34	1	0	4	0	0	0	5	558.7
33	1	0	4	0	0	0	5	558.7
32	1	0	4	0	0	0	5	558.7
31	1	0	4	0	0	0	5	558.7
30	1	0	4	0	0	0	5	558.7
29	1	0	4	0	0	0	5	558.7
28	1	0	4	0	0	0	5	558.7
27	1	0	4	0	0	0	5	558.7
26	1	0	4	0	0	0	5	558.7
25	1	0	4	0	0	0	5	558.7
24	1	0	4	0	0	0	5	558.7
23	1	0	2	0	1	0	4	558.7
22	5	0	3	0	0	0	8	749.1
21	5	0	3	0	0	0	8	749.1
20	5	0	3	0	0	0	8	749.1
19	5	0	3	0	0	0	8	749.1
18	5	0	3	0	0	0	8	749.1
17	5	0	3	0	0	0	8	749.1
16	5	0	3	0	0	0	8	749.1
15	5	0	3	0	0	0	8	749.1
14	5	0	3	0	0	0	8	749.1
13	5	0	3	0	0	0	8	749.1
12	3	0	1	0	1	0	5	683.1
11	6	1	4	0	0	0	11	973.4
10	6	1	4	0	0	0	11	973.4
9	6	1	4	0	0	0	11	973.4
8	6	1	4	0	0	0	11	973.4
7	6	1	4	0	0	0	11	973.4
6	6	1	4	0	0	0	11	973.4
5	6	1	1	0	1	0	9	973.4
4	4	1	2	1	4	2	14	1637.6
3	4	1	2	1	4	2	14	1637.6
2M	1	1	1	0	5	0	8	1269.1
2	1	1	1	0	5	0	8	1637.6
1M	0	0	0	0	0	0	0	902.9
1	0	0	0	0	0	0	0	1510.1

Totals	120	11	120	2	20	5	278	31,963.30
---------------	-----	----	-----	---	----	---	-----	-----------

Unit Mix	1 br and den	47%
	2 br	43%
	3bd and 2bd with den	10%

Amenity		Required	Provided
	Total Amenity (SM)	1112	1475.4
	Total Indoor Amenity (SM)	556	687.8
	Total Outdoor Amenity (SM)	40	787.6

Parking Stats	Parking	# of stalls	Gross SM
	B1	48	2379
	B2	47	2379
	B3	51	2379
	Totals	146	7137

Bike Parking	per dwelling unit	number of dwelling units	Total Required	Total Provided
	Short Term	0.1	278	28 @ Lvl M1a
	Long Term	0.9	278	250 @ Lvl M1b
	Totals	1.0	278	550 total

31 PARLIAMENT STREET STATISTICS - 37 STOREY OPTION - 3BR COMBINATIONS

Floor	1bd	1bd+den	2bd	2bd+den	3bd	3bd+den	Subtotals	Gross Area
Mech								
37	1	0	4	0	0	0	5	558.7
36	1	0	4	0	0	0	5	558.7
35	1	0	4	0	0	0	5	558.7
34	1	0	4	0	0	0	5	558.7
33	1	0	4	0	0	0	5	558.7
32	1	0	4	0	0	0	5	558.7
31	1	0	4	0	0	0	5	558.7
30	1	0	4	0	0	0	5	558.7
29	1	0	4	0	0	0	5	558.7
28	1	0	4	0	0	0	5	558.7
27	1	0	4	0	0	0	5	558.7
26	1	0	4	0	0	0	5	558.7
25	1	0	4	0	0	0	5	558.7
24	1	0	4	0	0	0	5	558.7
23	1	0	2	0	1	0	4	558.7
22	5	0	3	0	0	0	8	749.1
21	5	0	3	0	0	0	8	749.1
20	5	0	3	0	0	0	8	749.1
19	5	0	3	0	0	0	8	749.1
18	5	0	3	0	0	0	8	749.1
17	5	0	3	0	0	0	8	749.1
16	5	0	3	0	0	0	8	749.1
15	5	0	3	0	0	0	8	749.1
14	5	0	3	0	0	0	8	749.1
13	5	0	3	0	0	0	8	749.1
12	3	0	1	0	1	0	5	683.1
11	2	1	4	0	0	0	2	973.4
10	2	1	4	0	0	0	2	973.4
9	2	1	4	0	0	0	2	973.4
8	2	1	4	0	0	0	2	973.4
7	2	1	4	0	0	0	2	973.4
6	2	1	4	0	0	0	2	973.4
5	6	1	1	0	1	0	9	973.4
4	4	1	2	1	4	2	14	1637.6
3	4	1	2	1	4	2	14	1637.6
2M	1	1	1	0	5	0	8	1269.1
2	1	1	1	0	5	0	8	1637.6
1M	0	0	0	0	0	0	0	902.9
1	0	0	0	0	0	0	0	1510.1

Totals	96	11	120	2	20	17	266	31,963.30
---------------	----	----	-----	---	----	----	-----	-----------

Unit Mix	1 br and den	40%
	2 br	45%
	3bd and 2bd with den	15%

Amenity		Required	Provided
	Total Amenity (SM)	1064	1475.4
	Total Indoor Amenity (SM)	532	687.8
	Total Outdoor Amenity (SM)	40	787.6

Parking Stats	Parking	# of stalls	Gross SM
	B1	48	2379
	B2	47	2379
	B3	51	2379
	Totals	146	7137

Bike Parking	per dwelling unit	number of dwelling units	Total Required	Total Provided
	Short Term	0.1	266	27 @ Lvl M1a
	Long Term	0.9	266	239 @ Lvl M1b
	Totals	1.0	266	550 total



- LEGEND**
- PROJECT SITE
 - PROPOSED PROJECTS
 - PUBLIC PARKS
 - WATER

PREPARED FOR:
1150782 ONTARIO INC.
 NOTE: WITHOUT PREJUDICE AND FOR SETTLEMENT PURPOSES ONLY

PROJECT:
**31 PARLIAMENT STREET
 TORONTO, CANADA
 37 STOREY OPTION**

DRAWING:
EXPANDED CONTEXT PLAN

PROJECT NORTH
 TRUE NORTH

0 10 50 100 METERS
 SCALE 1:3000
 DATE: 4/12/2018 9:42:22 AM

ARQUITECTONICA





ARQUITECTONICA

PREPARED FOR:
1150782 ONTARIO INC.
 NOTE: WITHOUT PREJUDICE AND FOR SETTLEMENT PURPOSES ONLY

PROJECT:
**31 PARLIAMENT STREET
 TORONTO, CANADA
 37 STOREY OPTION**

DRAWING:
CONTEXT PLAN

 PROJECT NORTH
 TRUE NORTH
 SCALE 1:1500
 DATE: 4/12/2018 9:42:24 AM



PREPARED FOR:
1150782 ONTARIO INC.
 NOTE: WITHOUT PREJUDICE AND FOR SETTLEMENT PURPOSES ONLY

PROJECT:
**31 PARLIAMENT STREET
 TORONTO, CANADA
 37 STOREY OPTION**

DRAWING:
SITE PLAN

ARQUITECTONICA

PROJECT NORTH TRUE NORTH

SCALE 1:800 DATE: 4/12/2018 9:42:25 AM

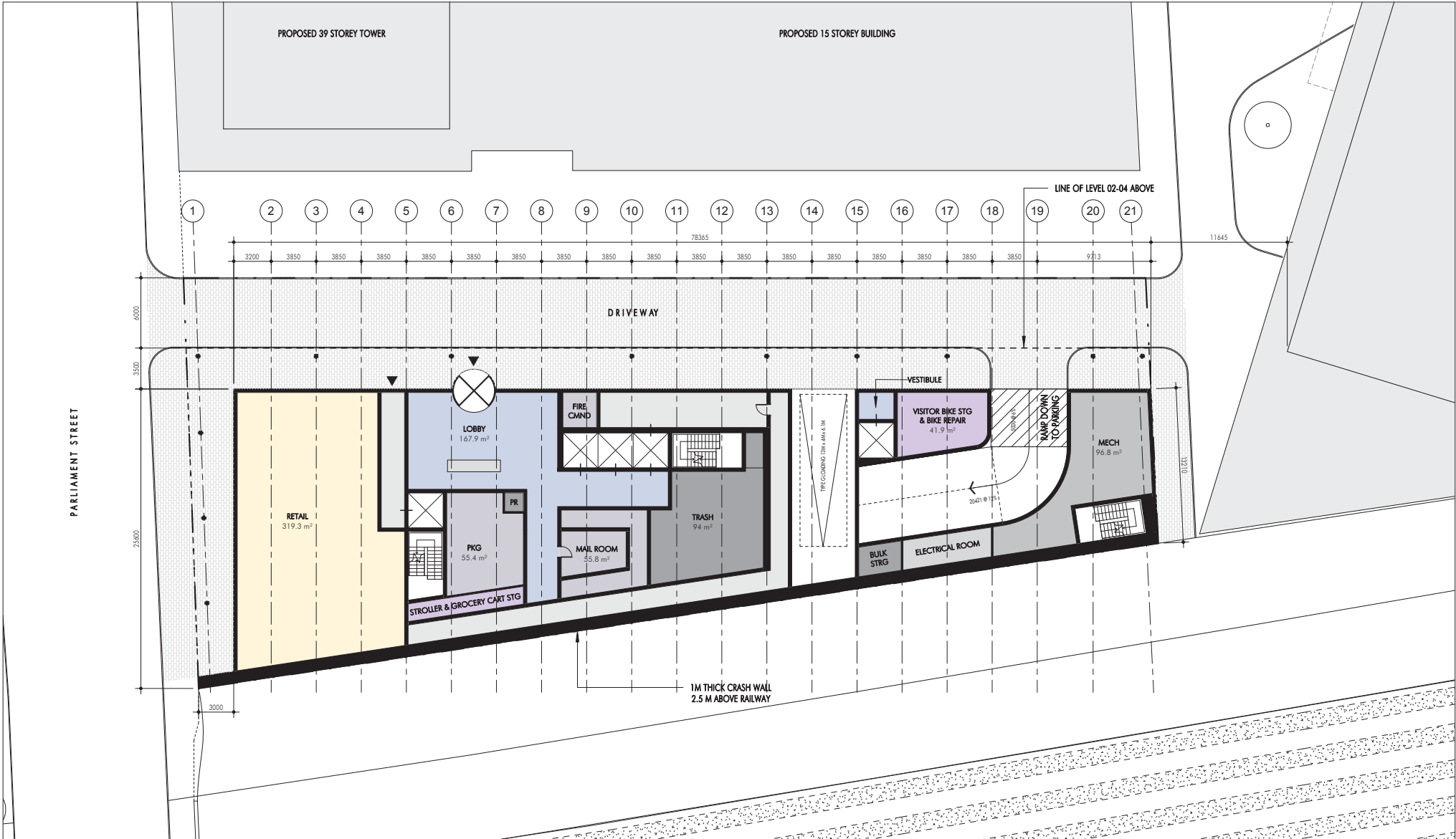

PREPARED FOR:
1150782 ONTARIO INC.

NOTE: WITHOUT PREJUDICE AND FOR SETTLEMENT PURPOSES ONLY

PROJECT:
**31 PARLIAMENT STREET
 TORONTO, CANADA
 37 STOREY OPTION**

DRAWING:
FLOOR PLAN - LEVEL 01 (1510.1 m2 GROSS AREA)

ARQUITECTONICA

PROJECT NORTH

TRUE NORTH

0 1 2 5 10 METERS

SCALE 1:300

DATE: 4/12/2018 9:42:27 AM

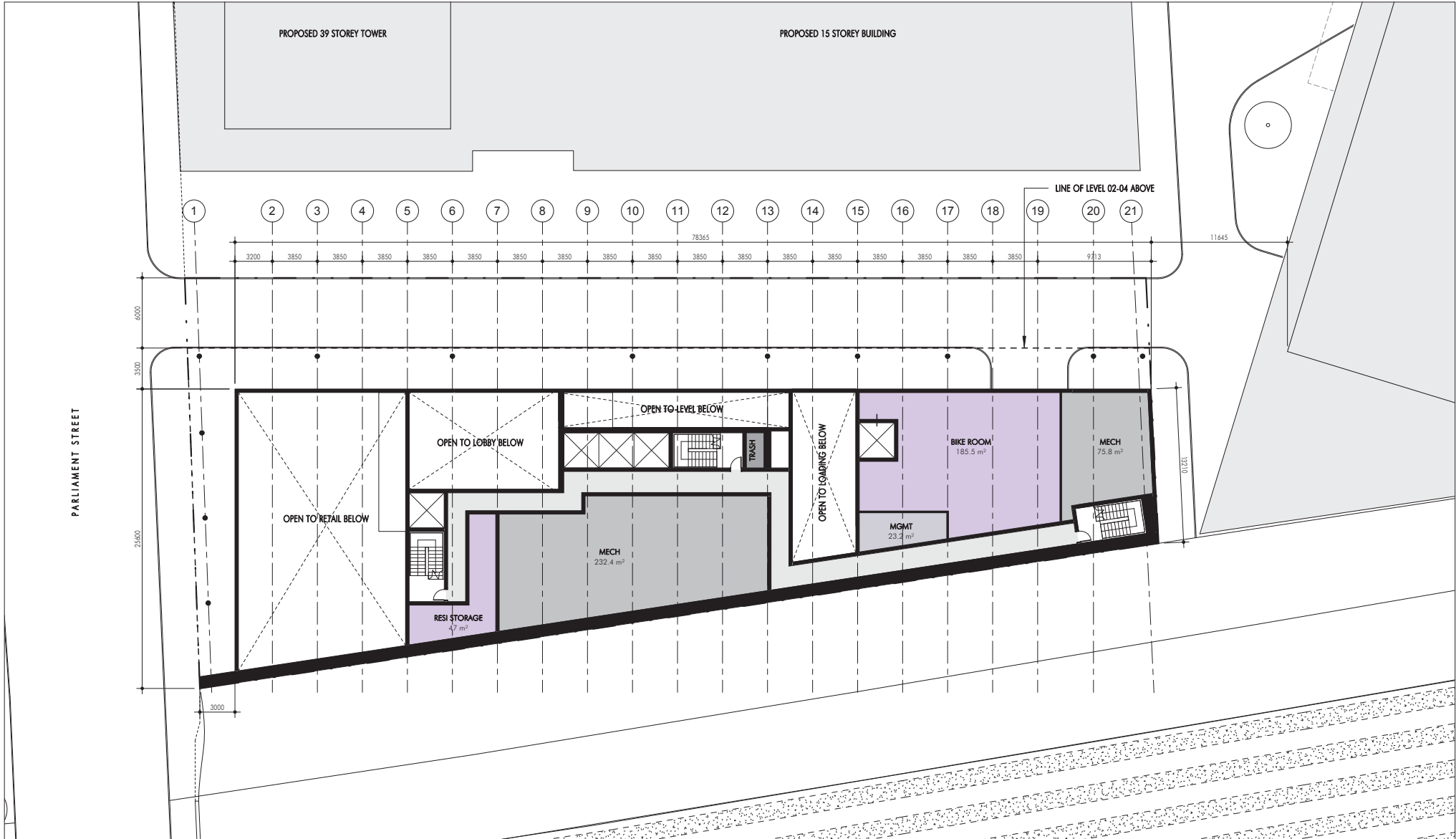

ARQUITECTONICA

PREPARED FOR:
1150782 ONTARIO INC.
 NOTE: WITHOUT PREJUDICE AND FOR SETTLEMENT PURPOSES ONLY

PROJECT:
**31 PARLIAMENT STREET
 TORONTO, CANADA
 37 STOREY OPTION**

DRAWING:
FLOOR PLAN - MEZZANINE 1A (902.9 m2 GROSS AREA)

PROJECT NORTH TRUE NORTH

 SCALE 1:300
 DATE: 4/12/2018 9:42:28 AM

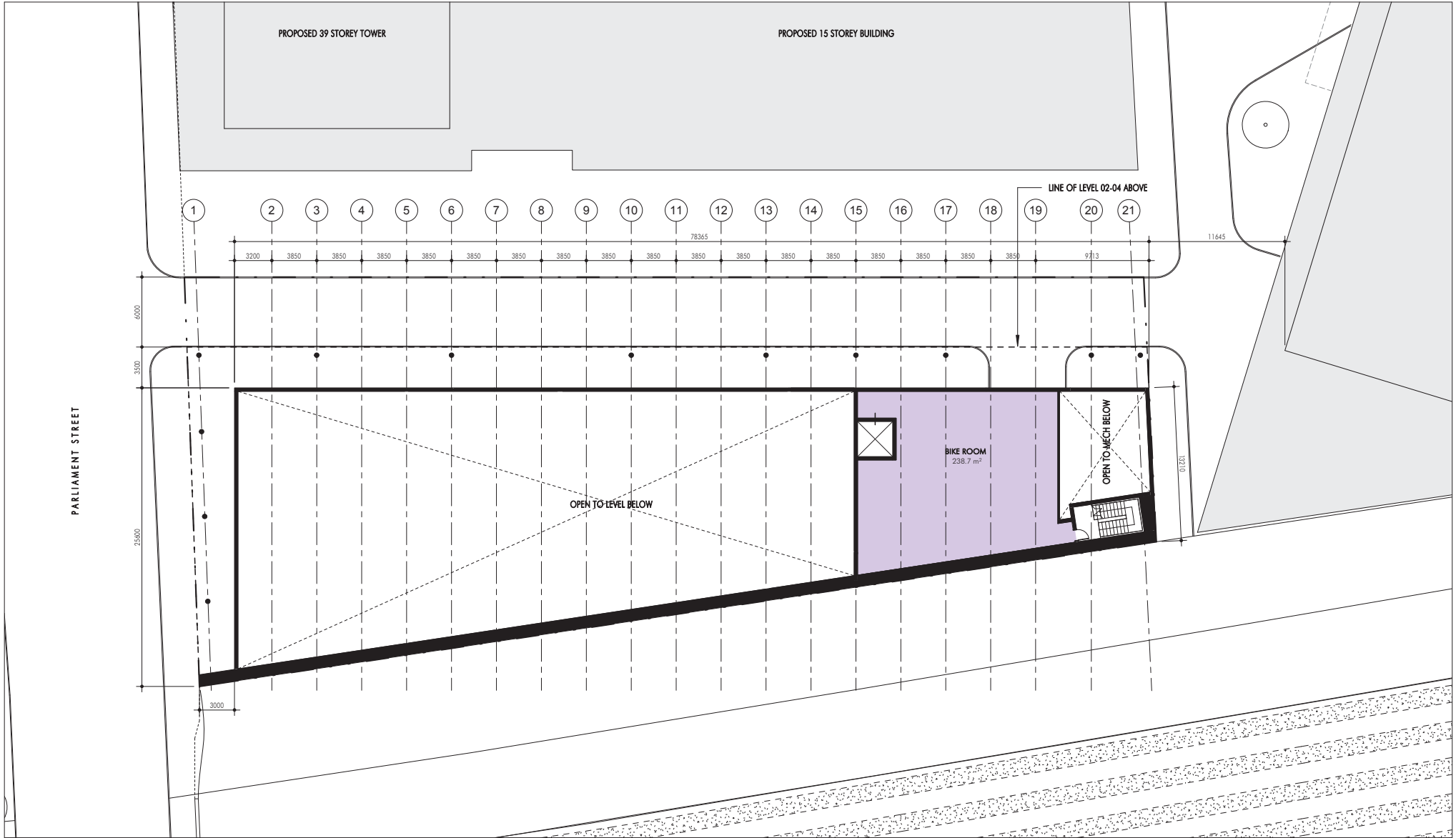

PREPARED FOR:
1150782 ONTARIO INC.
 NOTE: WITHOUT PREJUDICE AND FOR SETTLEMENT PURPOSES ONLY

PROJECT:
**31 PARLIAMENT STREET
 TORONTO, CANADA
 37 STOREY OPTION**

DRAWING:
FLOOR PLAN - MEZZANINE 1B (388.2 m2 GROSS AREA)

ARQUITECTONICA

PROJECT NORTH TRUE NORTH SCALE 1:300 DATE: 4/12/2018 9:42:28 AM

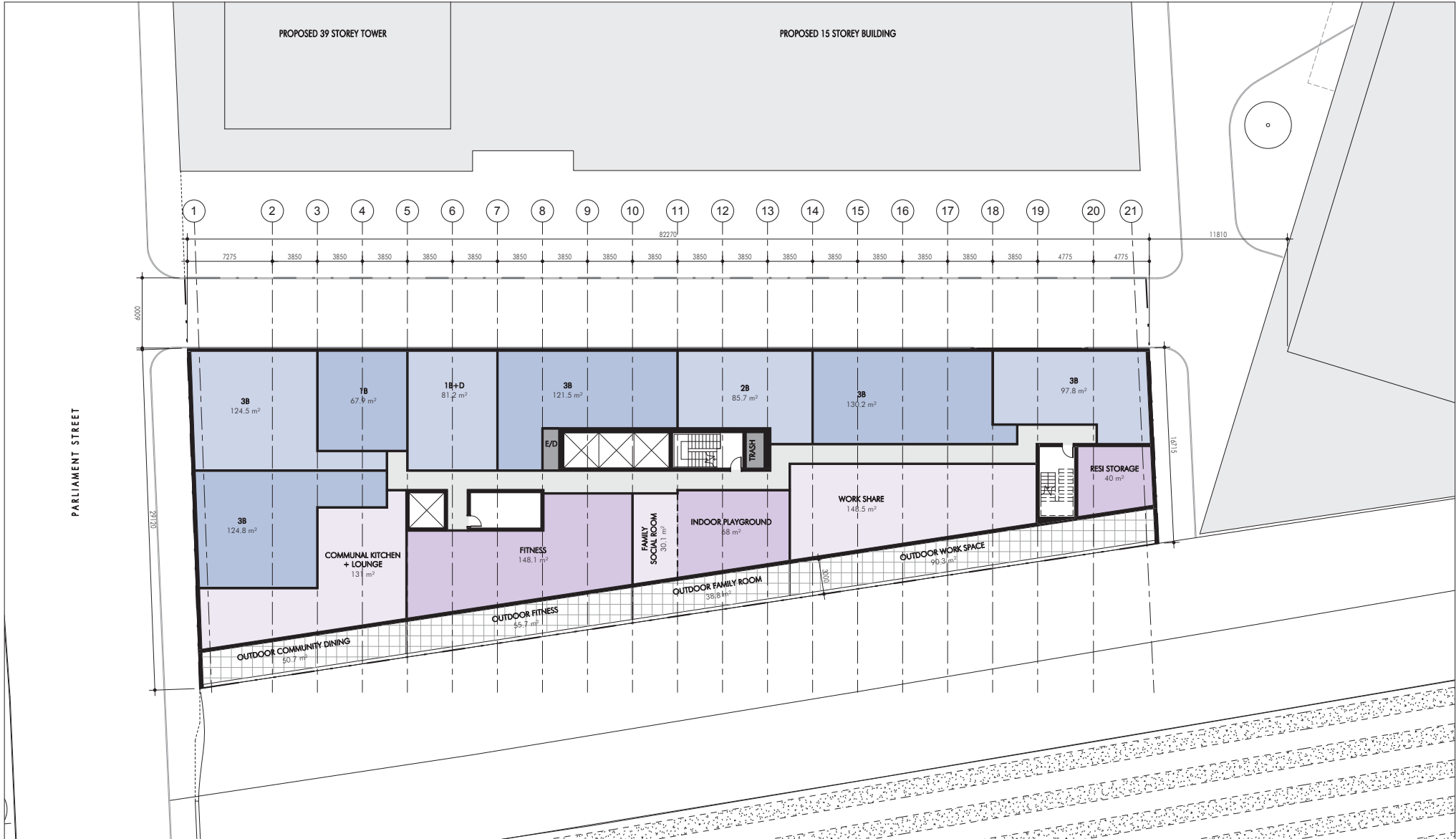

PREPARED FOR:
1150782 ONTARIO INC.

NOTE: WITHOUT PREJUDICE AND FOR SETTLEMENT PURPOSES ONLY

PROJECT:
**31 PARLIAMENT STREET
 TORONTO, CANADA
 37 STOREY OPTION**

DRAWING:
FLOOR PLAN - LEVEL 02 (1637.6 m2 GROSS AREA)

ARQUITECTONICA

PROJECT NORTH
 TRUE NORTH

0 1 2 5 10 METERS
 SCALE 1:300
 DATE: 4/12/2018 9:42:29 AM

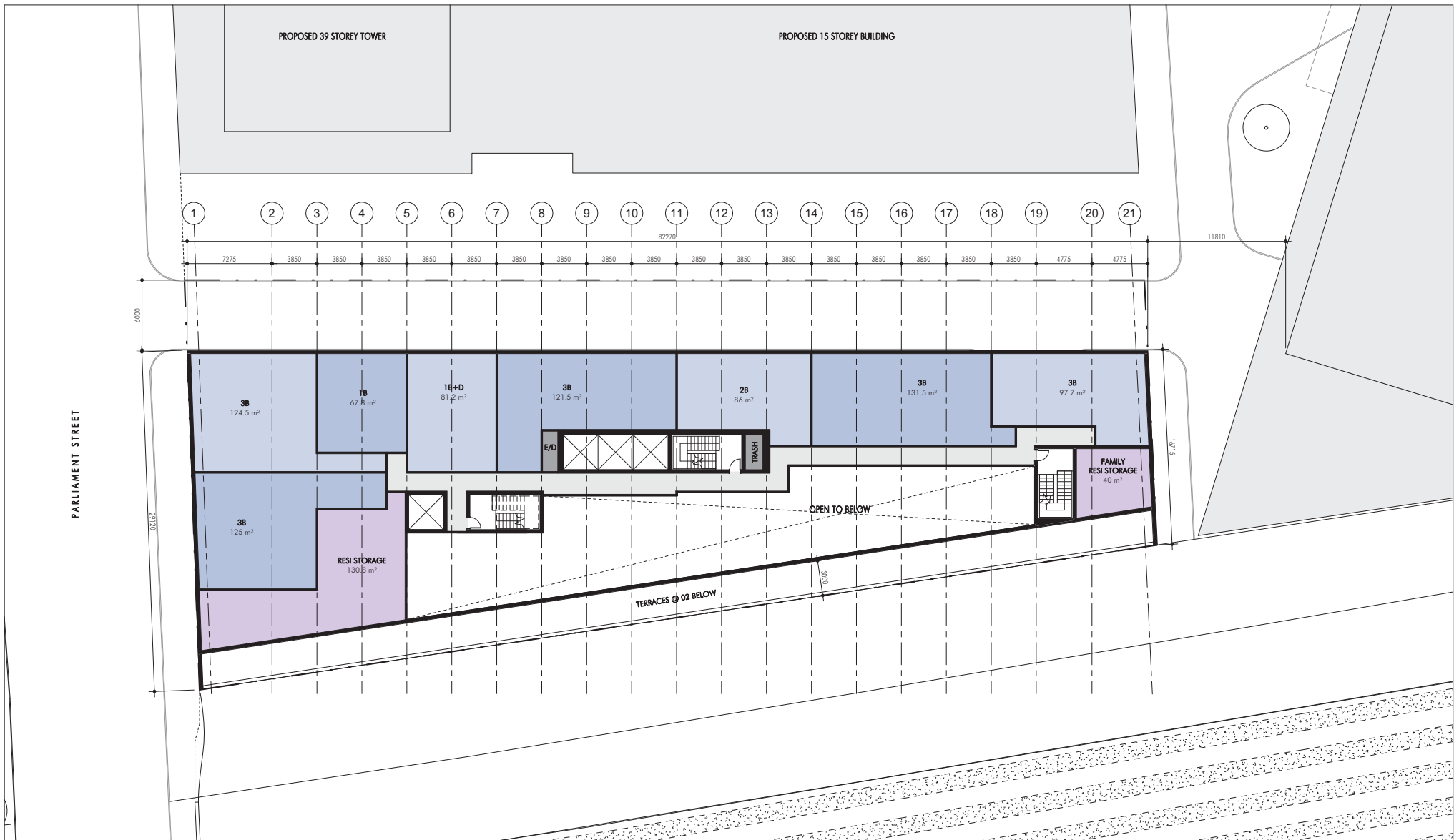

PREPARED FOR:
1150782 ONTARIO INC.
 NOTE: WITHOUT PREJUDICE AND FOR SETTLEMENT PURPOSES ONLY

PROJECT:
**31 PARLIAMENT STREET
 TORONTO, CANADA
 37 STOREY OPTION**

DRAWING:
FLOOR PLAN - LEVEL 2M (1269.1 m2 GROSS AREA)

PROJECT NORTH
 TRUE NORTH

0 1 2 5 10 METERS
 SCALE 1:300
 DATE: 4/12/2018 9:42:30 AM

ARQUITECTONICA

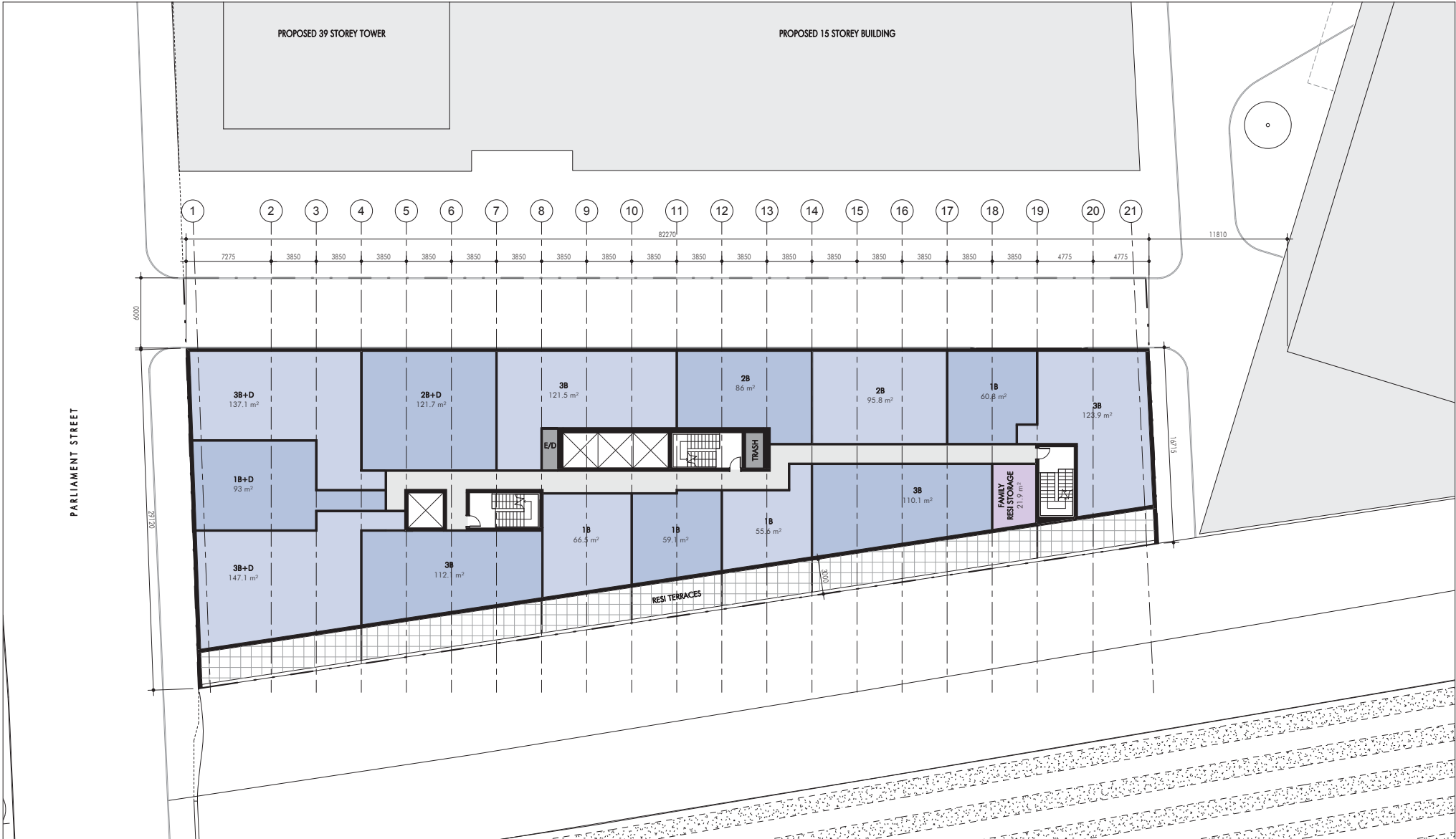

PREPARED FOR:
1150782 ONTARIO INC.

NOTE: WITHOUT PREJUDICE AND FOR SETTLEMENT PURPOSES ONLY

PROJECT:
**31 PARLIAMENT STREET
 TORONTO, CANADA
 37 STOREY OPTION**

DRAWING:
FLOOR PLAN - LEVEL 03-04 (1637.6 m2 GROSS AREA PER FLOOR)



0 1 2 5 10 METERS

SCALE 1:300

DATE: 4/12/2018 9:42:30 AM

ARQUITECTONICA

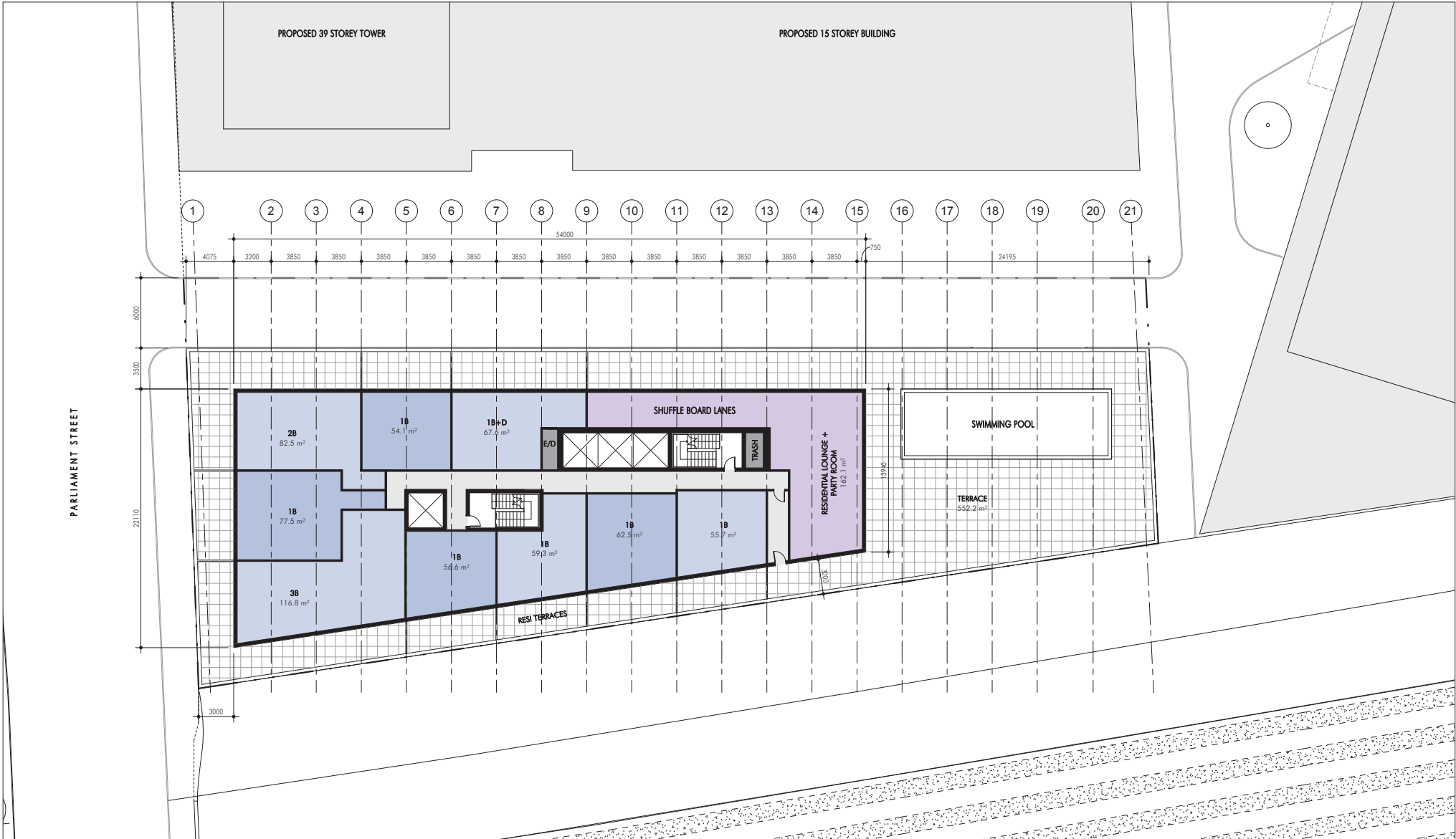

ARQUITECTONICA

PREPARED FOR:
1150782 ONTARIO INC.
 NOTE: WITHOUT PREJUDICE AND FOR SETTLEMENT PURPOSES ONLY

PROJECT:
**31 PARLIAMENT STREET
 TORONTO, CANADA
 37 STOREY OPTION**

DRAWING:
FLOOR PLAN - LEVEL 05 (973.4 m2 GROSS AREA)

PROJECT NORTH TRUE NORTH
 SCALE 1:300
 DATE: 4/12/2018 9:42:31 AM

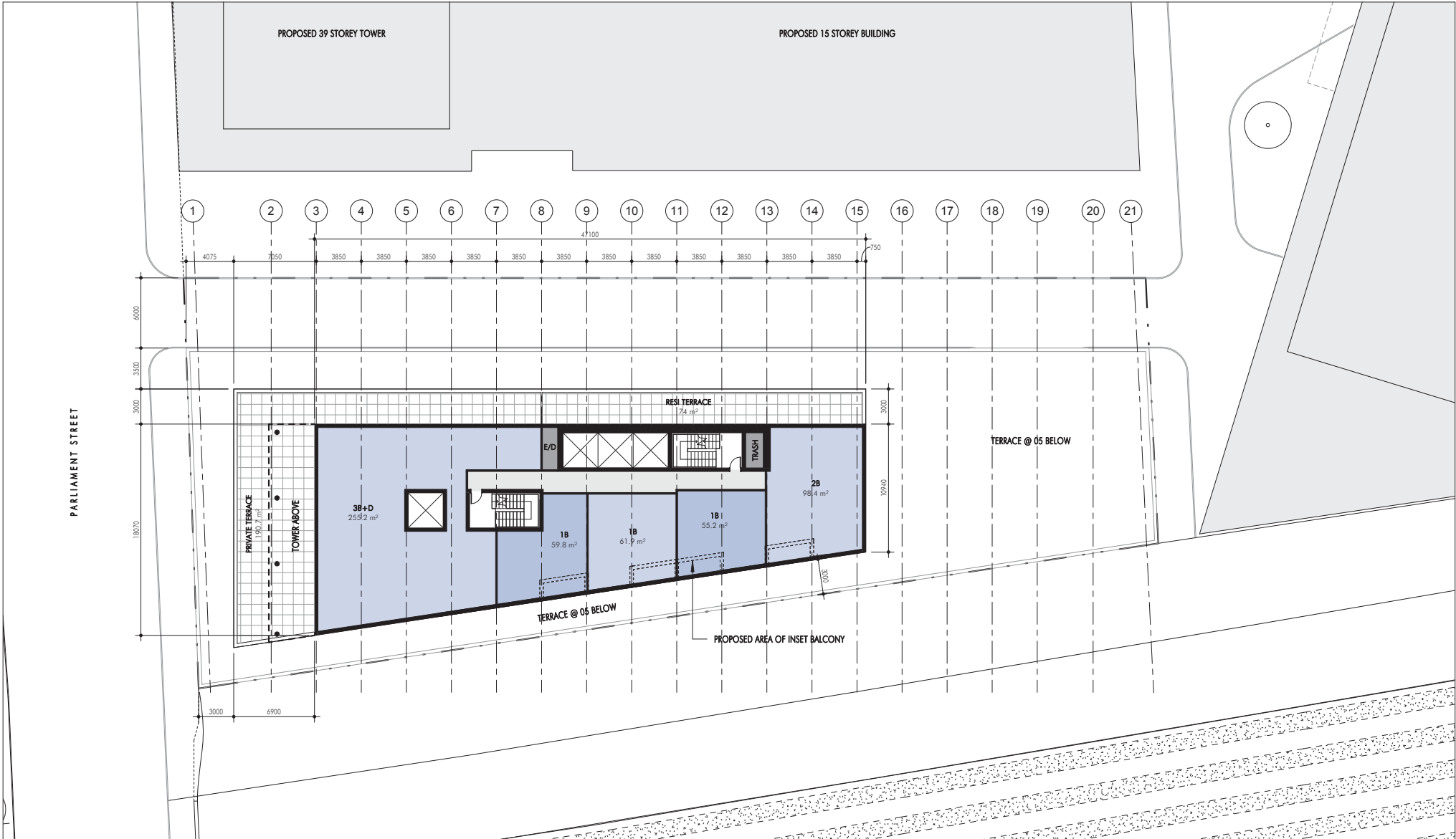

PREPARED FOR:
1150782 ONTARIO INC.
 NOTE: WITHOUT PREJUDICE AND FOR SETTLEMENT PURPOSES ONLY

PROJECT:
**31 PARLIAMENT STREET
 TORONTO, CANADA
 37 STOREY OPTION**

DRAWING:
FLOOR PLAN - LEVEL 12 (683.1 m2 GROSS AREA)

PROJECT NORTH
 TRUE NORTH

0 1 2 5 10 METERS
 SCALE: 1:300
 DATE: 4/12/2018 9:42:32 AM

ARQUITECTONICA

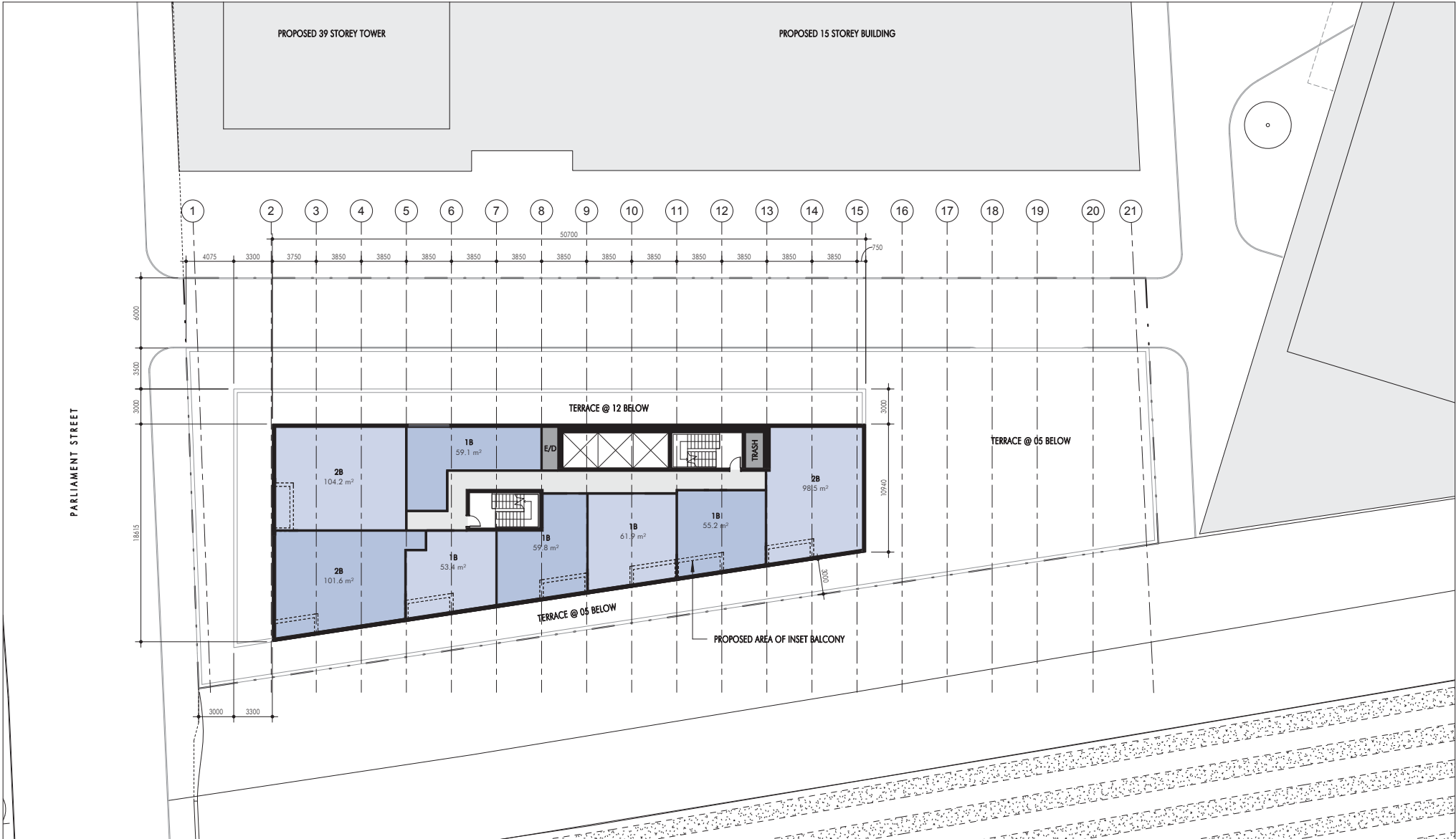

PREPARED FOR:
1150782 ONTARIO INC.
 NOTE: WITHOUT PREJUDICE AND FOR SETTLEMENT PURPOSES ONLY

PROJECT:
**31 PARLIAMENT STREET
 TORONTO, CANADA
 37 STOREY OPTION**

DRAWING:
FLOOR PLAN - LEVEL 13-22 (749.1 m² GROSS AREA PER FLOOR)

ARQUITECTONICA

PROJECT NORTH

TRUE NORTH

SCALE 1:300

DATE: 4/12/2018 9:42:33 AM

0 1 2 5 10 METERS

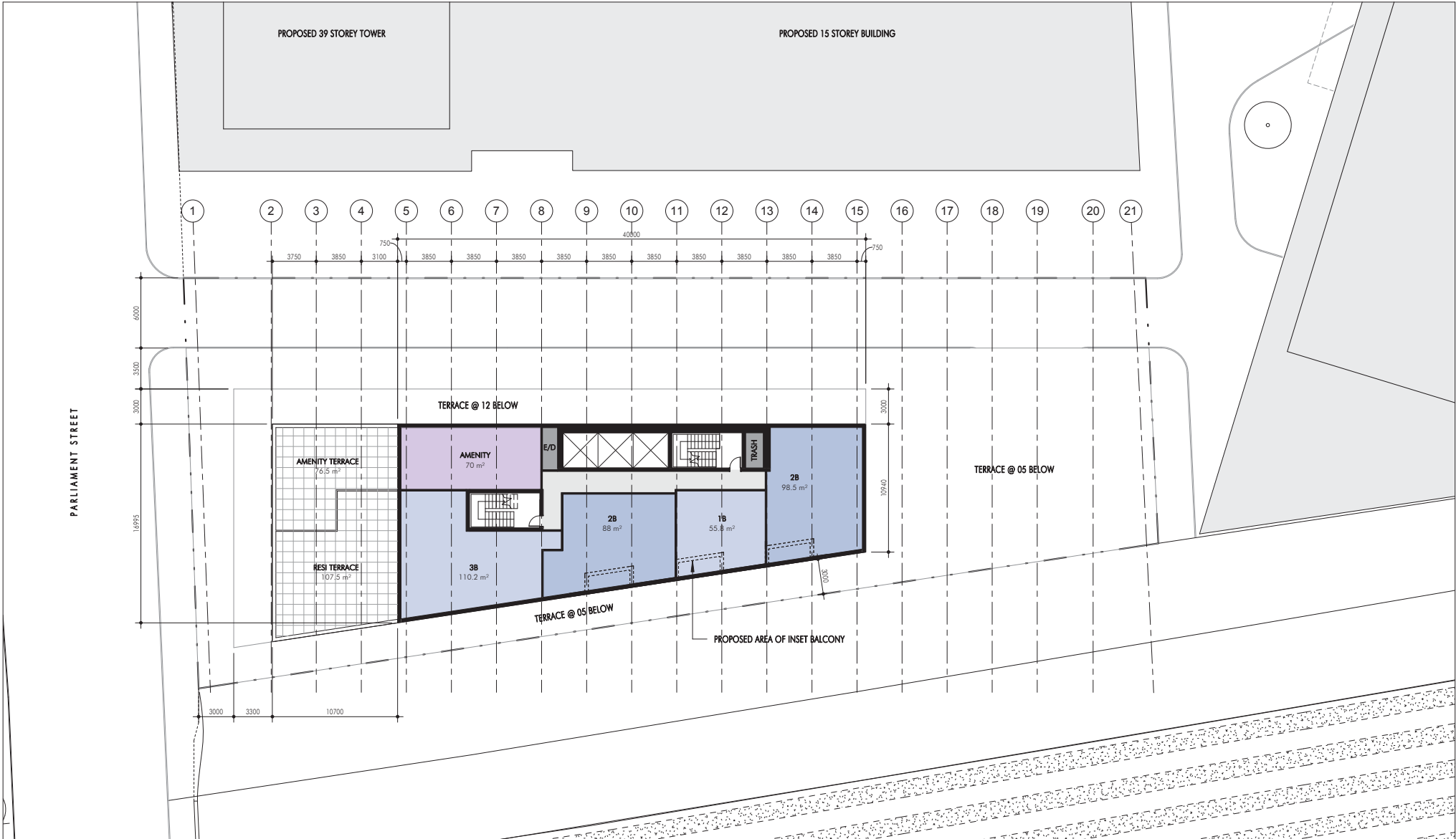

PREPARED FOR:
1150782 ONTARIO INC.

NOTE: WITHOUT PREJUDICE AND FOR SETTLEMENT PURPOSES ONLY

PROJECT:
**31 PARLIAMENT STREET
 TORONTO, CANADA
 37 STOREY OPTION**

DRAWING:
FLOOR PLAN - LEVEL 23 (558.7 m2 GROSS AREA)



0 1 2 5 10 METERS

SCALE 1:300

DATE: 4/12/2018 9:42:34 AM

ARQUITECTONICA

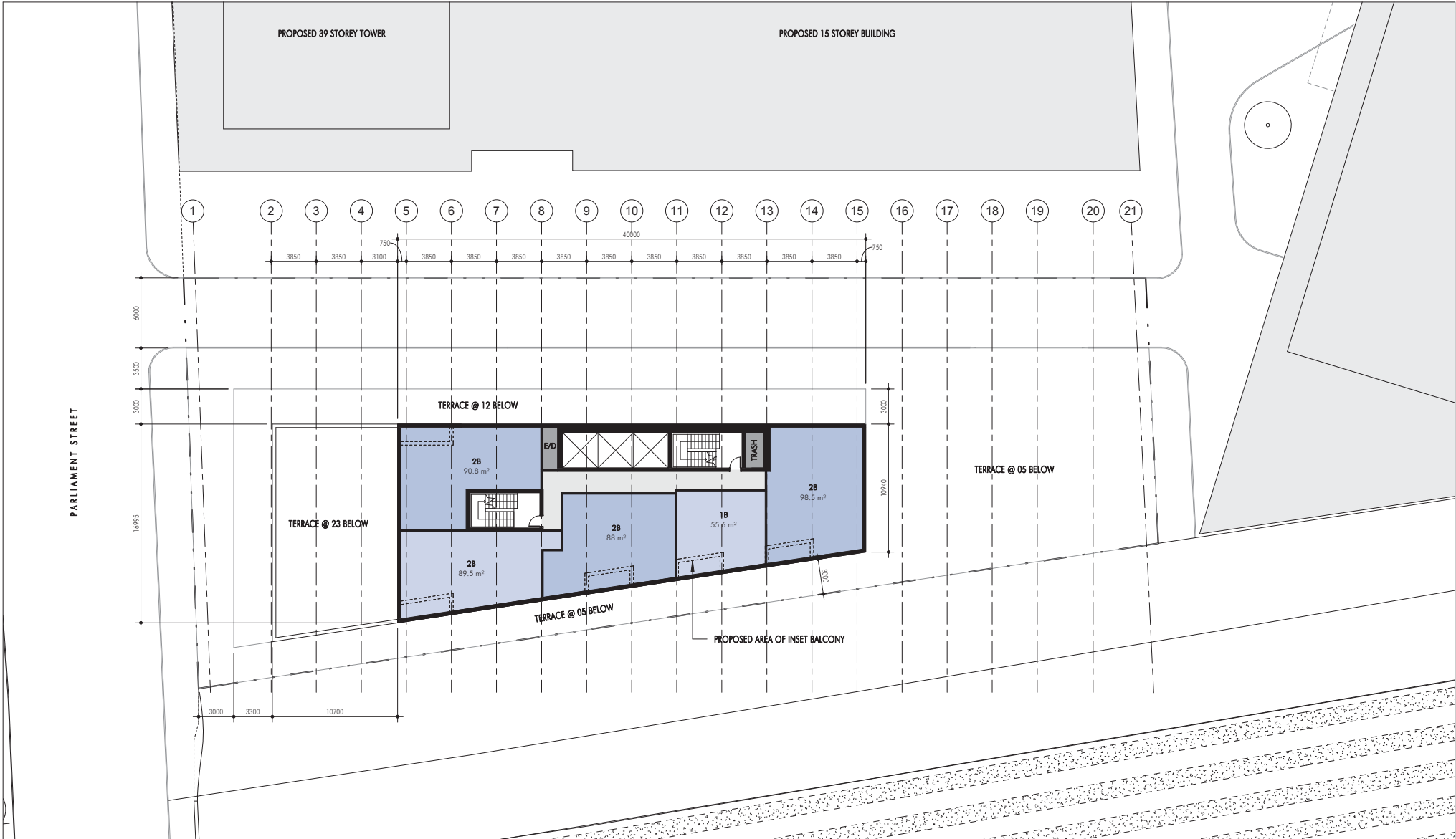

ARQUITECTONICA

PREPARED FOR:
1150782 ONTARIO INC.
 NOTE: WITHOUT PREJUDICE AND FOR SETTLEMENT PURPOSES ONLY

PROJECT:
**31 PARLIAMENT STREET
 TORONTO, CANADA
 37 STOREY OPTION**

DRAWING:
FLOOR PLAN - LEVEL 24-37 (558.7 m2 GROSS AREA PER FLOOR)

 PROJECT NORTH
 TRUE NORTH
 SCALE 1:300
 DATE: 4/12/2018 9:42:34 AM

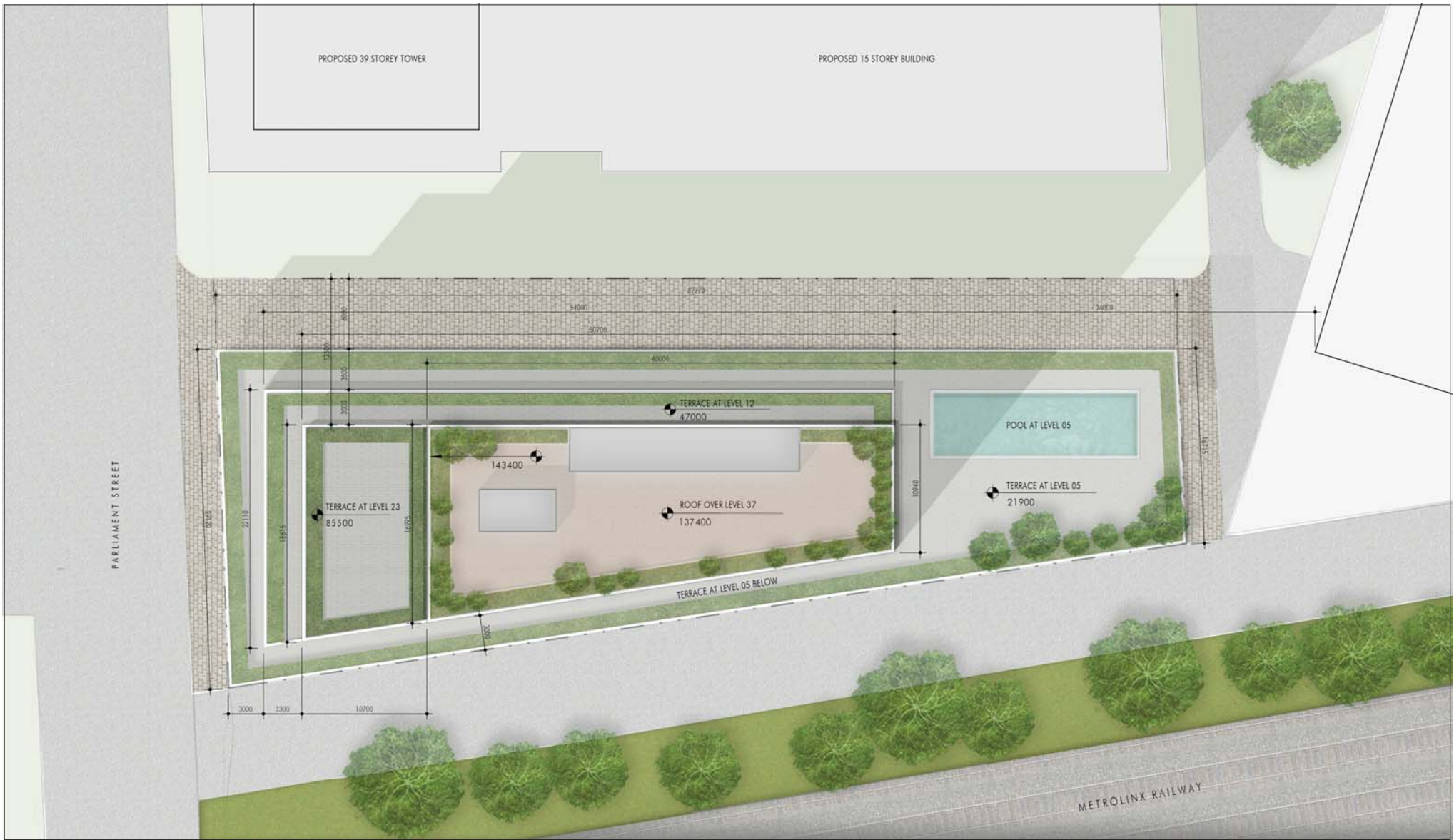

PREPARED FOR:
1150782 ONTARIO INC.
 NOTE: WITHOUT PREJUDICE AND FOR SETTLEMENT PURPOSES ONLY

PROJECT:
**31 PARLIAMENT STREET
 TORONTO, CANADA
 37 STOREY OPTION**

DRAWING:
FLOOR PLAN - ROOF LEVEL

PROJECT NORTH
 TRUE NORTH

0 1 2 5 10 METERS
 SCALE 1:300
 DATE: 4/12/2018 9:42:36 AM

ARQUITECTONICA

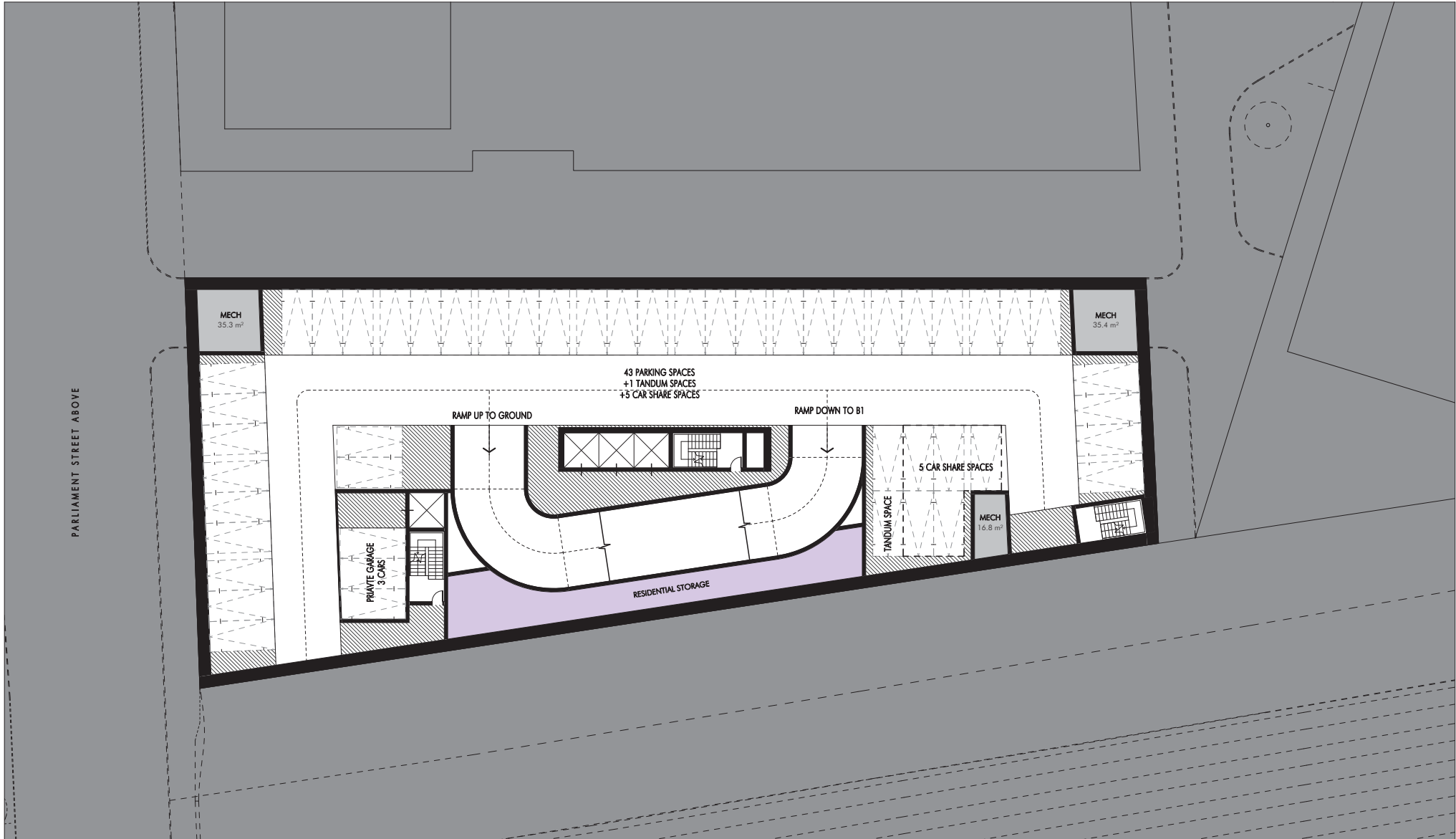

PARLIAMENT STREET ABOVE

PREPARED FOR:
1150782 ONTARIO INC.
 NOTE: WITHOUT PREJUDICE AND FOR SETTLEMENT PURPOSES ONLY

PROJECT:
**31 PARLIAMENT STREET
 TORONTO, CANADA
 37 STOREY OPTION**

DRAWING:
FLOOR PLAN - PARKING LEVEL B1 (2379.7 m2 GROSS AREA)

ARQUITECTONICA

PROJECT NORTH TRUE NORTH

SCALE 1:300

DATE: 4/12/2018 9:42:36 AM

0 1 2 5 10 METERS

NO COPIES, TRANSMISSION, REPRODUCTIONS OR ELECTRONIC MANIPULATION OF ANY PORTION OF THESE DRAWINGS IN WHOLE OR IN PART ARE TO BE MADE WITHOUT THE EXPRESS WRITTEN PERMISSION OF ARQUITECTONICA INTERNATIONAL. ALL DESIGNS INDICATED IN THESE DRAWINGS ARE PROPERTY OF ARQUITECTONICA INTERNATIONAL. ALL COPYRIGHTS RESERVED (C) 2018.

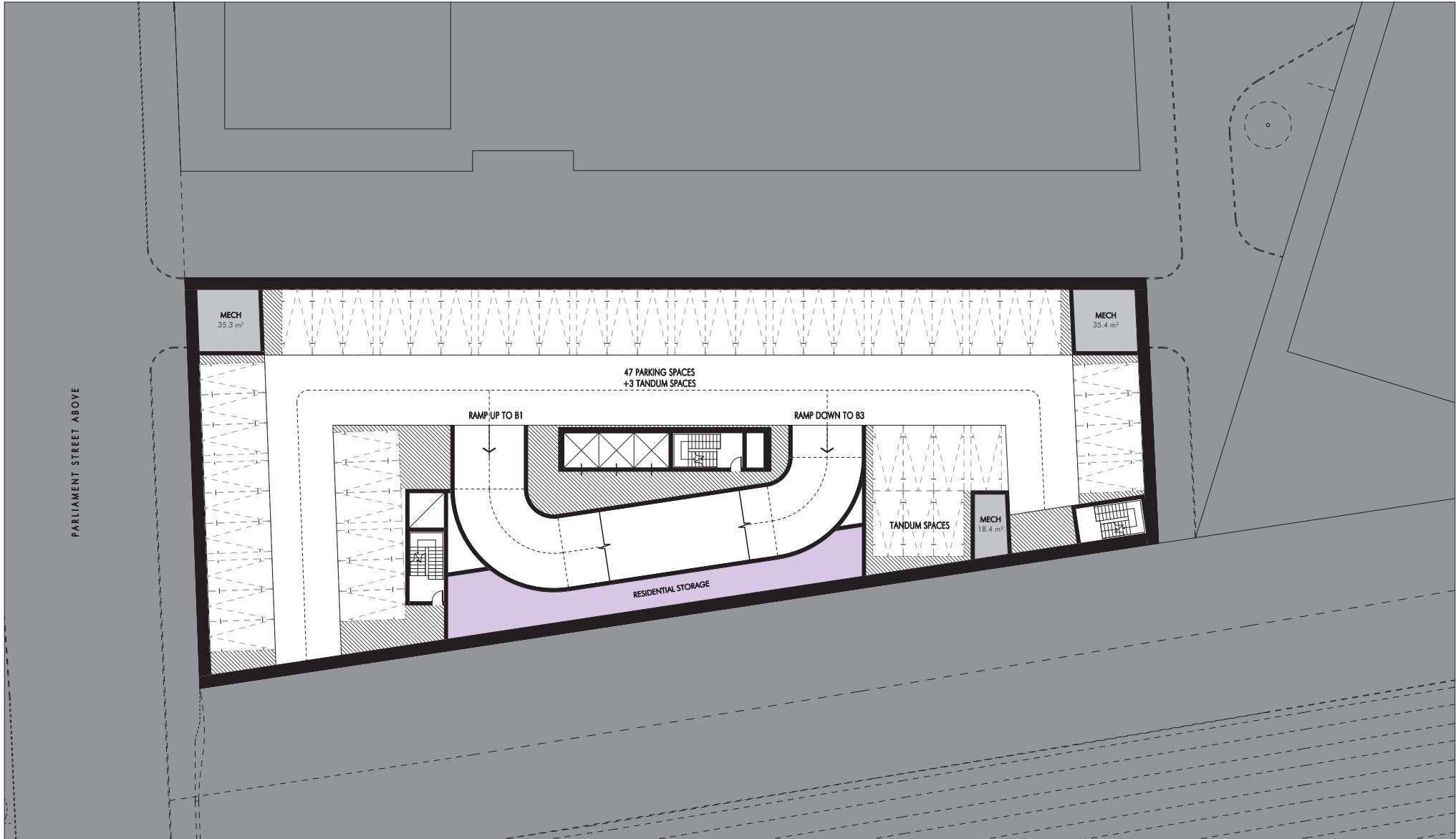

PREPARED FOR:
1150782 ONTARIO INC.

NOTE: WITHOUT PREJUDICE AND FOR SETTLEMENT PURPOSES ONLY

PROJECT:
**31 PARLIAMENT STREET
 TORONTO, CANADA
 37 STOREY OPTION**

DRAWING:
FLOOR PLAN - PARKING LEVEL B2 (2379.7 m2 GROSS AREA)

PROJECT NORTH

TRUE NORTH

0 1 2 5 10 METERS

SCALE 1:300

DATE: 4/12/2018 9:42:37 AM

ARQUITECTONICA

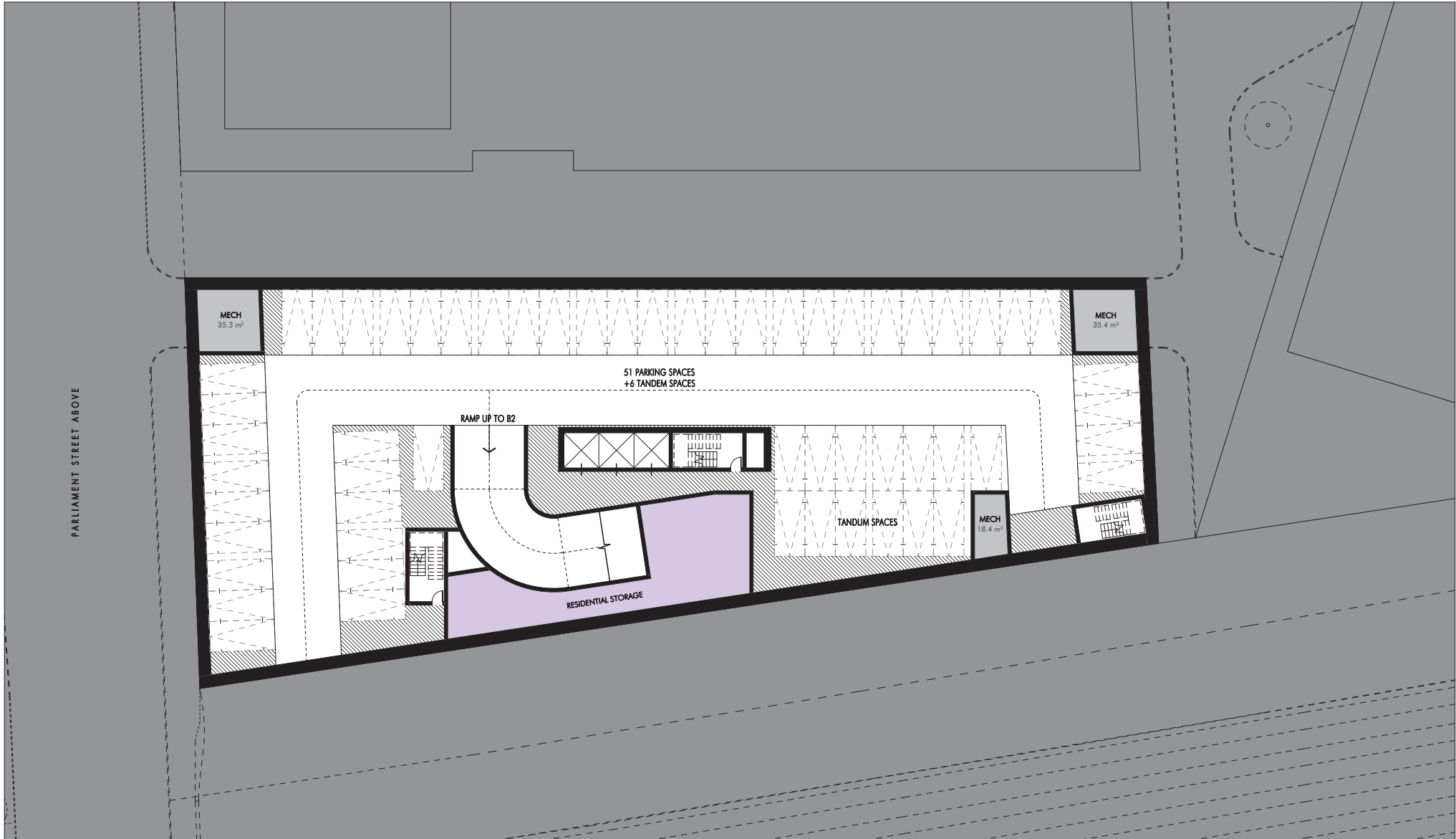

PREPARED FOR:
1150782 ONTARIO INC.

NOTE: WITHOUT PREJUDICE AND FOR SETTLEMENT PURPOSES ONLY

PROJECT:
**31 PARLIAMENT STREET
 TORONTO, CANADA
 37 STOREY OPTION**

DRAWING:
FLOOR PLAN - PARKING LEVEL B3 (2379.7 m2 GROSS AREA)

ARQUITECTONICA

PROJECT NORTH

TRUE NORTH

0 1 2 5 10 METERS

SCALE 1:300

DATE: 4/12/2018 9:42:38 AM

TYPICAL 1BR
UNIT PLANS

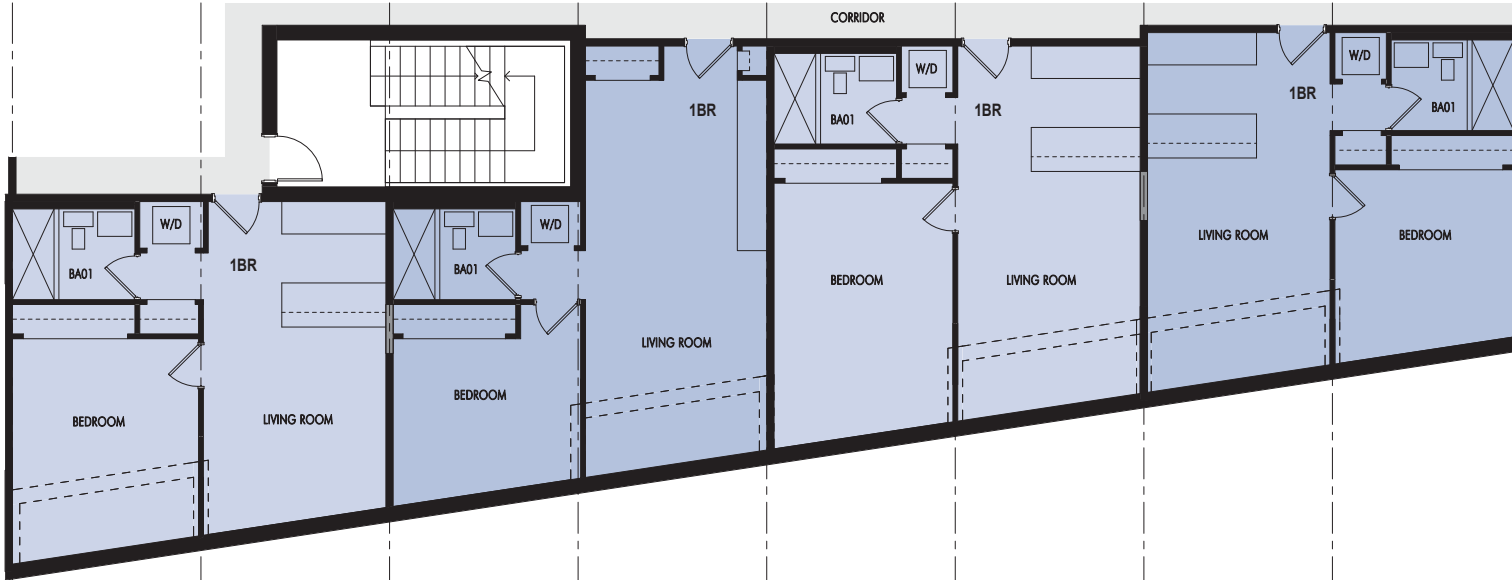

TYPICAL 3BR+D
COMBINATION DIAGRAM

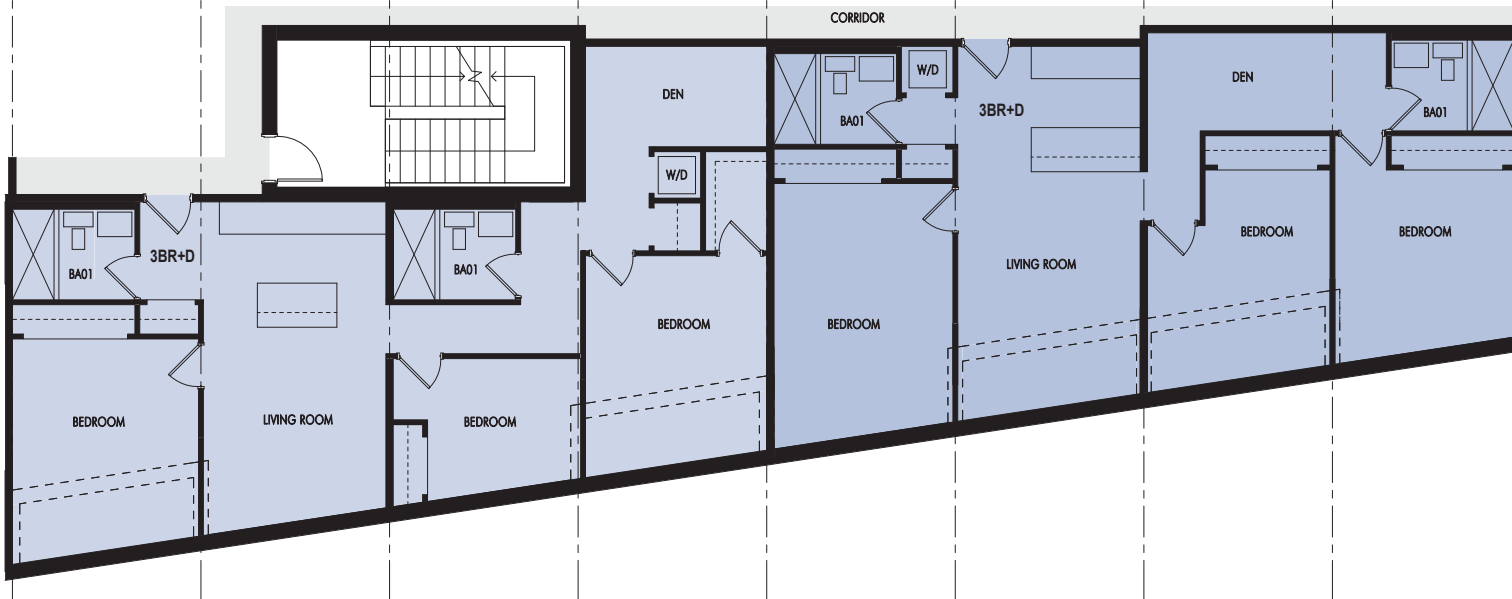

ARQUITECTONICA

PREPARED FOR:
1150782 ONTARIO INC.
NOTE: WITHOUT PREJUDICE AND FOR
SETTLEMENT PURPOSES ONLY

PROJECT:
**31 PARLIAMENT STREET
TORONTO, CANADA
37 STOREY OPTION**

DRAWING:
COMBINATION UNIT DIAGRAMS

PROJECT
NORTH

TRUE
NORTH

0 1 2 5 METERS

SCALE 1:100

DATE: 4/12/2018 9:42:39 AM

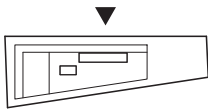

- 20
- 19
- 18
- 17
- 16
- 15
- 14
- 13
- 12
- 11
- 10
- 9
- 8
- 7
- 6
- 5
- 4
- 3
- 2

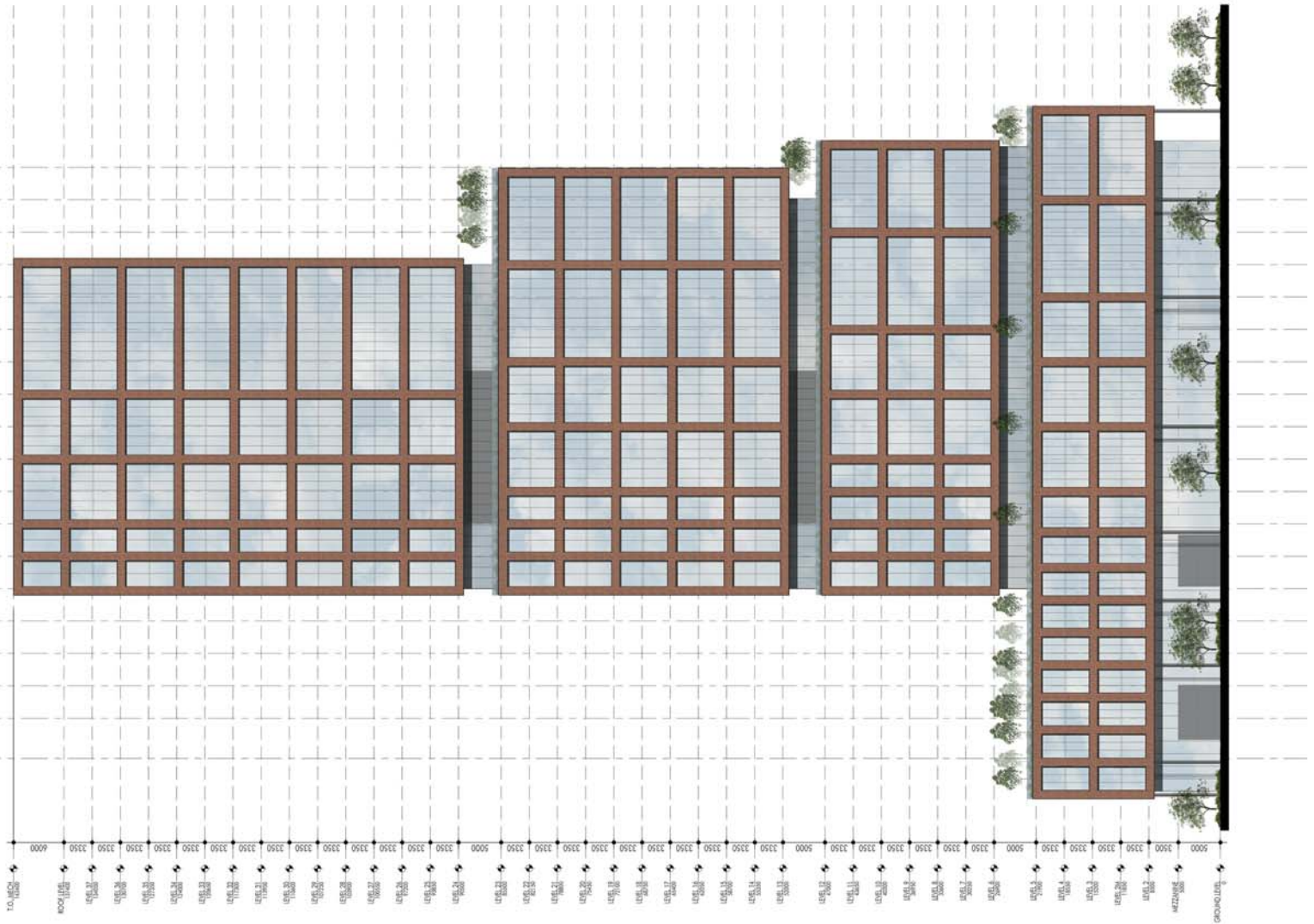

ARQUITECTONICA

PREPARED FOR:
1150782 ONTARIO INC.

NOTE: WITHOUT PREJUDICE AND FOR
SETTLEMENT PURPOSES ONLY

PROJECT:
**31 PARLIAMENT STREET
TORONTO, CANADA
37 STOREY OPTION**

DRAWING:
NORTH ELEVATION

0 1 2 5 10 METERS
SCALE 1:500
DATE: 4/12/2018 9:42:40 AM

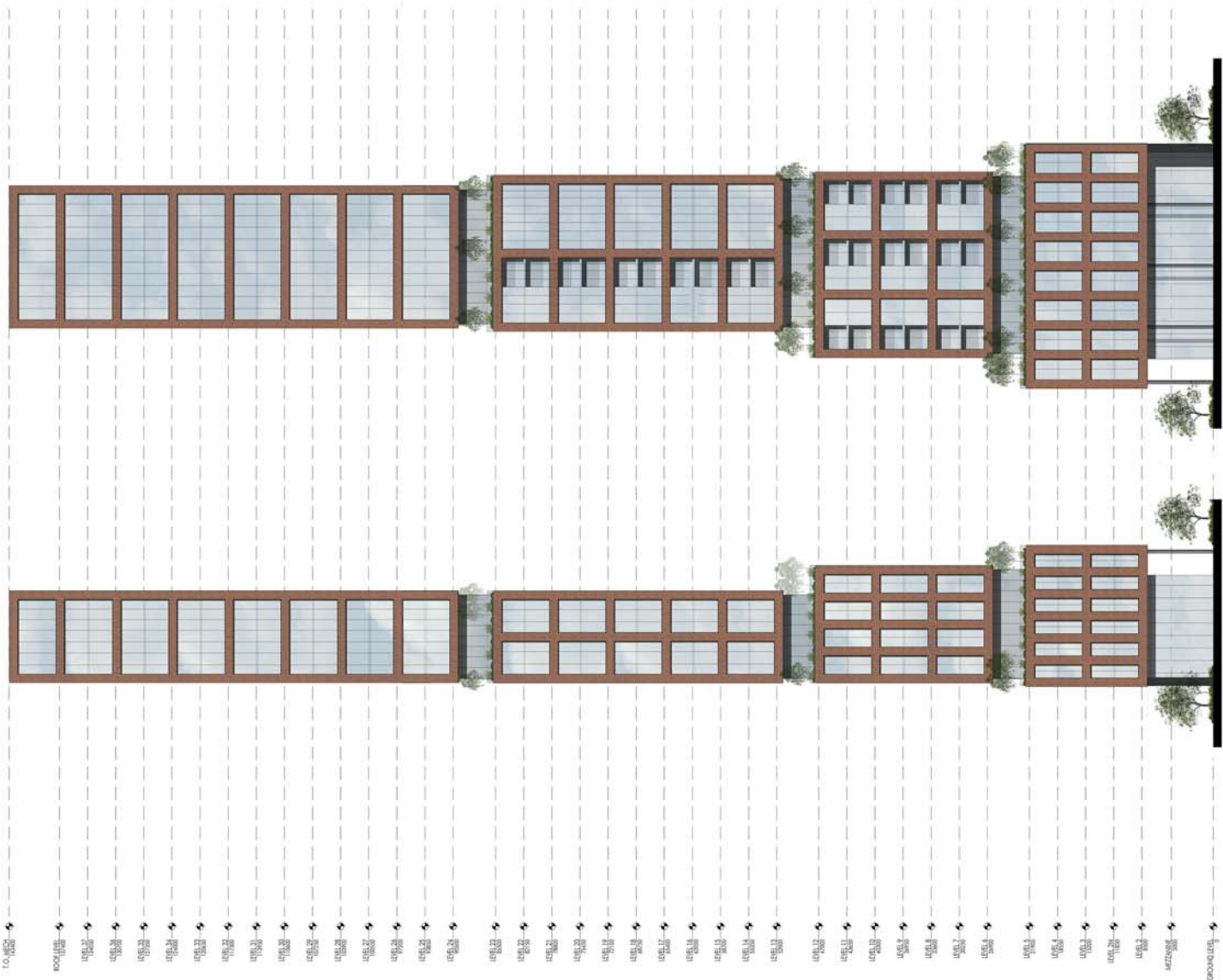
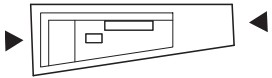



WEST ELEVATION

EAST ELEVATION

PREPARED FOR:
1150782 ONTARIO INC.
 NOTE: WITHOUT PREJUDICE AND FOR
 SETTLEMENT PURPOSES ONLY

PROJECT:
**31 PARLIAMENT STREET
 TORONTO, CANADA
 37 STOREY OPTION**

DRAWING:
EAST & WEST ELEVATIONS

PROJECT NORTH  TRUE NORTH 

SCALE 1:500 

DATE: 4/12/2018 9:42:44 AM

ARQUITECTONICA

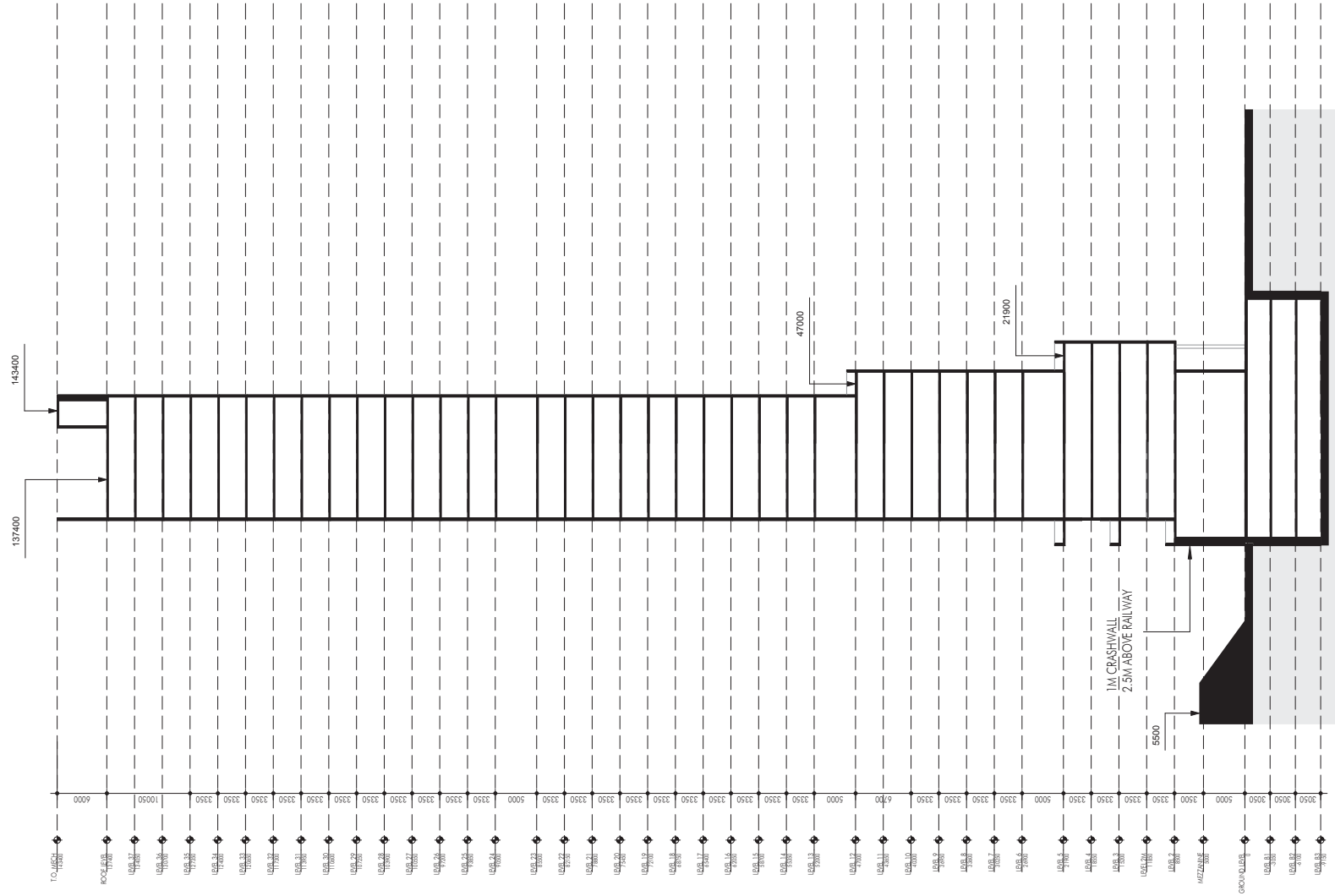
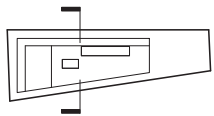

PREPARED FOR:
1150782 ONTARIO INC.
 NOTE: WITHOUT PREJUDICE AND FOR SETTLEMENT PURPOSES ONLY

PROJECT:
**31 PARLIAMENT STREET
 TORONTO, CANADA
 37 STOREY OPTION**

DRAWING:
NORTH-SOUTH SECTION

ARQUITECTONICA



DATE: 4/12/2018 9:42:45 AM



ARQUITECTONICA

PREPARED FOR:
1150782 ONTARIO INC.
NOTE: WITHOUT PREJUDICE AND FOR
SETTLEMENT PURPOSES ONLY

PROJECT:
**31 PARLIAMENT STREET
TORONTO, CANADA
37 STOREY OPTION**

DRAWING:
VIEW LOOKING SOUTHEAST

PROJECT
NORTH

TRUE
NORTH

DATE: 4/12/2018 9:42:46 AM



ARQUITECTONICA

PREPARED FOR:
1150782 ONTARIO INC.

NOTE: WITHOUT PREJUDICE AND FOR
SETTLEMENT PURPOSES ONLY

PROJECT:
**31 PARLIAMENT STREET
TORONTO, CANADA
37 STOREY OPTION**

DRAWING:
MIDRISE VIEW LOOKING NORTHEAST

DATE: 4/12/2018 9:42:49 AM

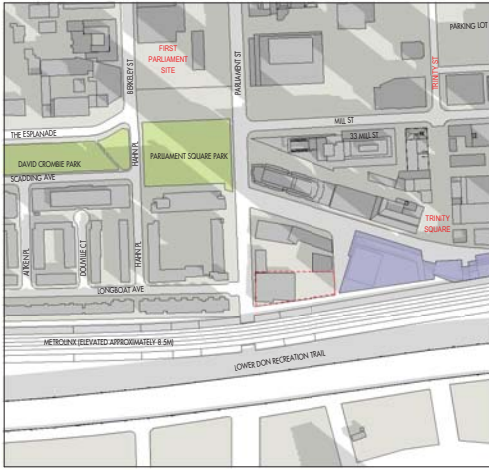

MARCH 21, 9:18AM

EXISTING

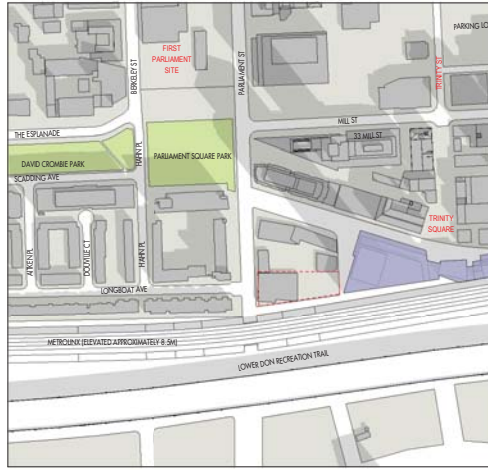

MARCH 21, 10:18AM

EXISTING

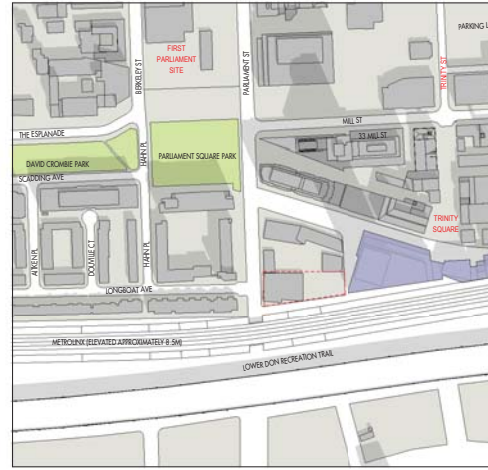

MARCH 21, 11:18AM

EXISTING

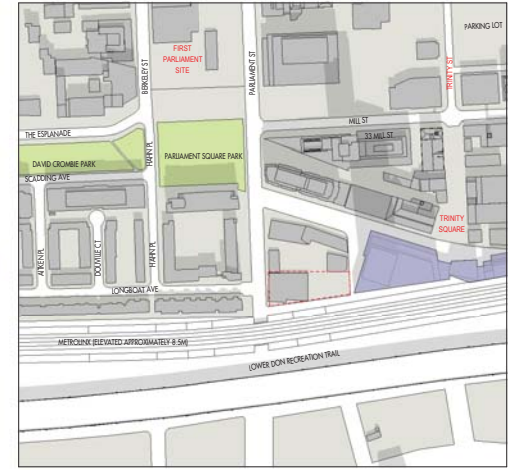

MARCH 21, 12:18PM

EXISTING

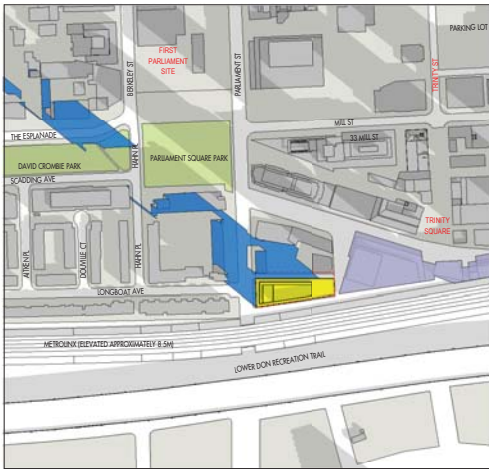

MARCH 21, 9:18AM

PROPOSED

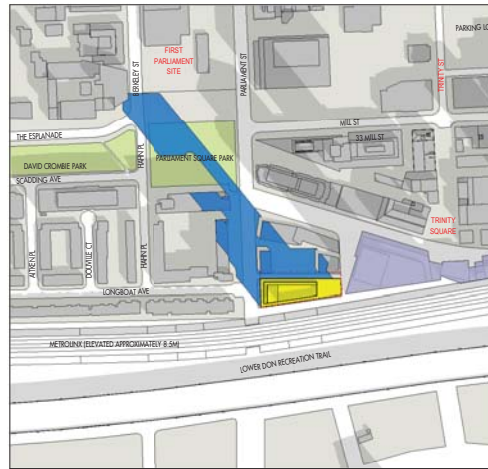

MARCH 21, 10:18AM

PROPOSED

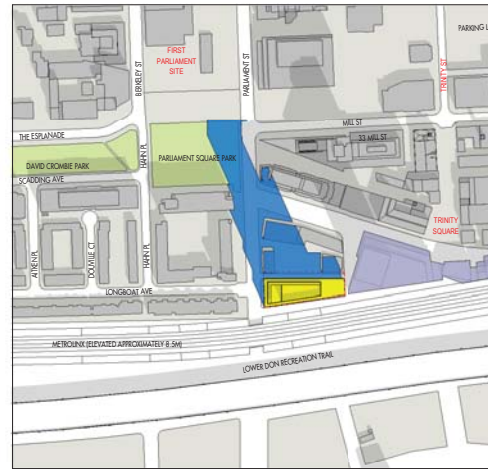

MARCH 21, 11:18AM

PROPOSED

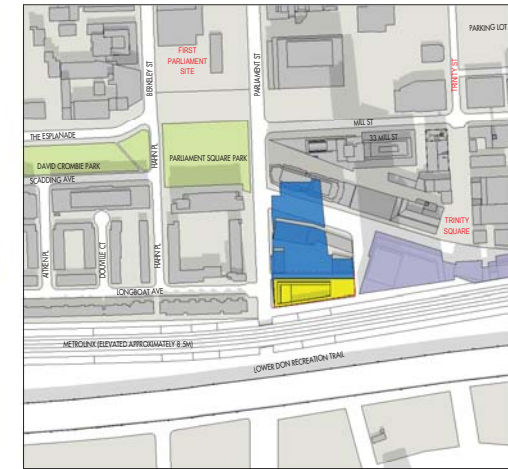

MARCH 21, 12:18PM

PROPOSED

LEGEND

- PROJECT SITE
- NET SHADOW IMPACT
- EXISTING SHADOWS
- EXISTING PARKLAND
- PROPOSED DEVELOPMENTS

PREPARED FOR:
1150782 ONTARIO INC.
 NOTE: WITHOUT PREJUDICE AND FOR SETTLEMENT PURPOSES ONLY

PROJECT:
**31 PARLIAMENT STREET
 TORONTO, CANADA
 37 STOREY OPTION**

DRAWING:
SHADOW STUDY - MARCH

ARQUITECTONICA

PROJECT NORTH
 TRUE NORTH
 0 20 50 100 200 METERS
 SCALE 1:5000
 DATE: 4/12/2018 9:42:59 AM

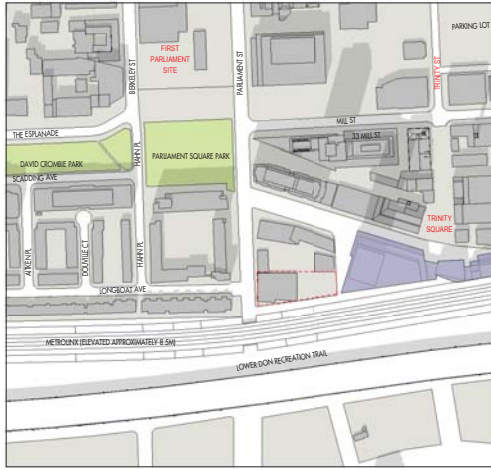

MARCH 21, 1:18PM

EXISTING

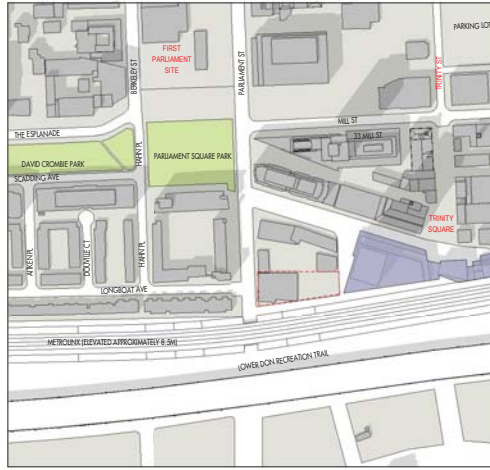

MARCH 21, 2:18PM

EXISTING

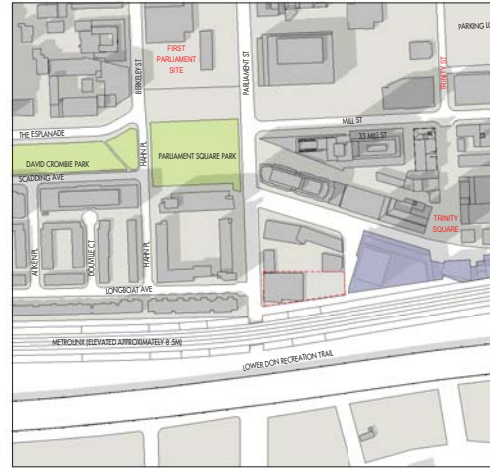

MARCH 21, 3:18PM

EXISTING

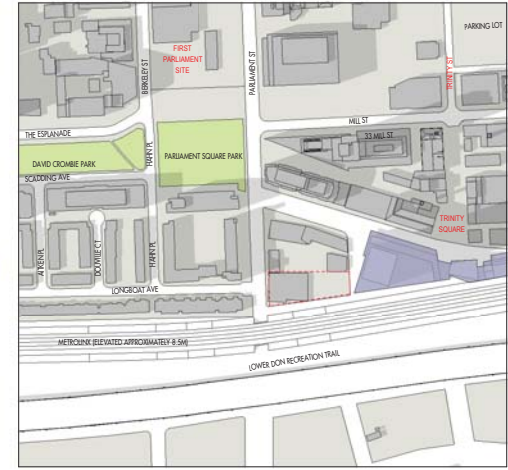

MARCH 21, 4:18PM

EXISTING

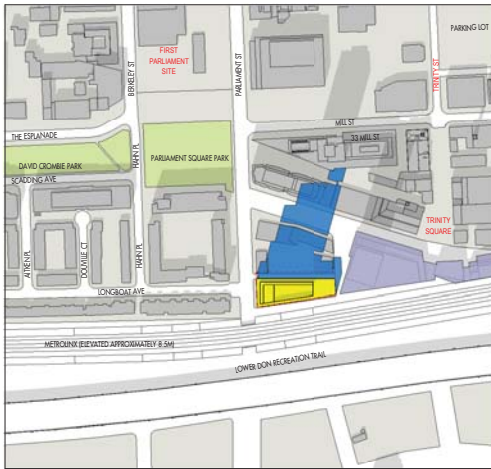

MARCH 21, 1:18PM

PROPOSED

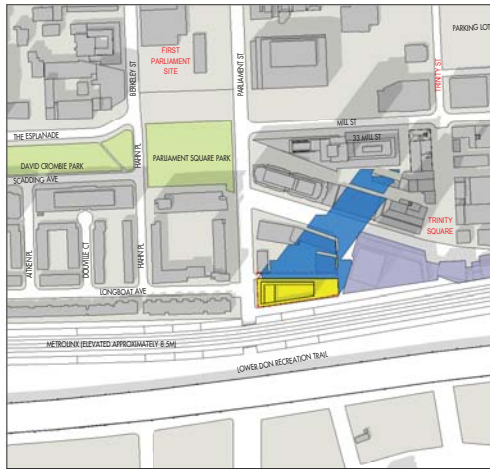

MARCH 21, 2:18PM

PROPOSED

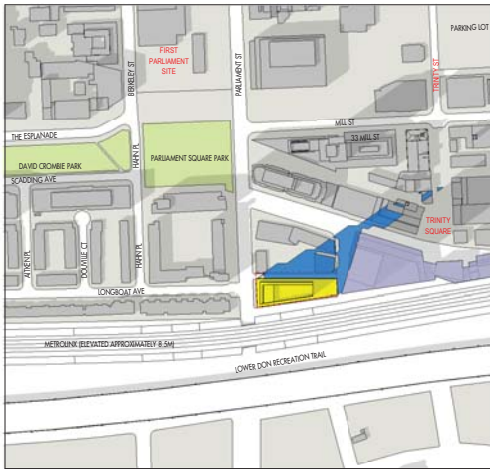

MARCH 21, 3:18PM

PROPOSED

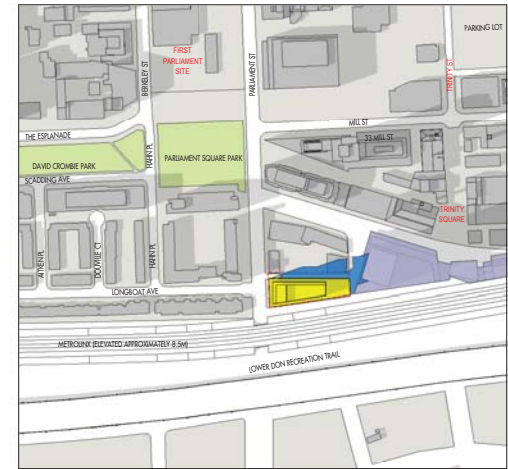

MARCH 21, 4:18PM

PROPOSED

LEGEND

- PROJECT SITE
- NET SHADOW IMPACT
- EXISTING SHADOWS
- EXISTING PARKLAND
- PROPOSED DEVELOPMENTS

PREPARED FOR:
1150782 ONTARIO INC.
 NOTE: WITHOUT PREJUDICE AND FOR SETTLEMENT PURPOSES ONLY

PROJECT:
**31 PARLIAMENT STREET
 TORONTO, CANADA
 37 STOREY OPTION**

DRAWING:
SHADOW STUDY - MARCH

ARQUITECTONICA

PROJECT NORTH
 TRUE NORTH
 0 20 50 100 200 METERS
 SCALE 1:5000
 DATE: 4/12/2018 9:43:10 AM

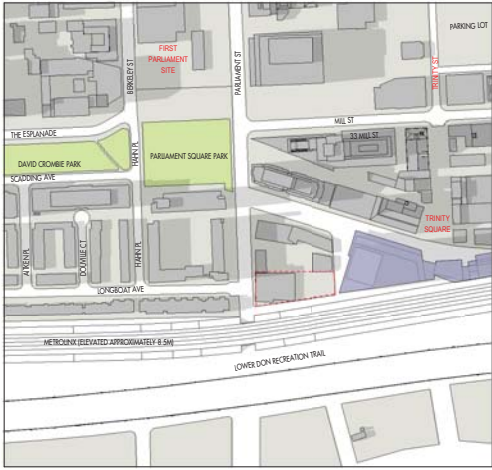

MARCH 21, 5:18PM

EXISTING

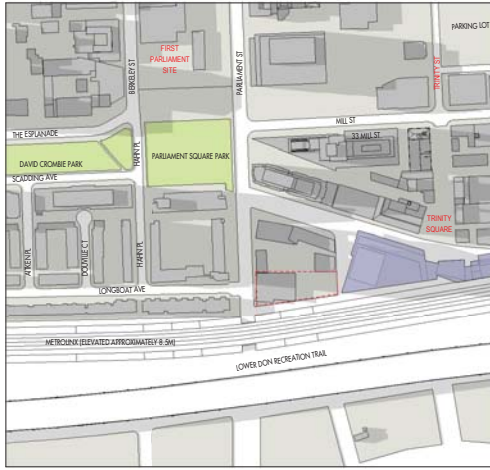

MARCH 21, 6:18PM

EXISTING

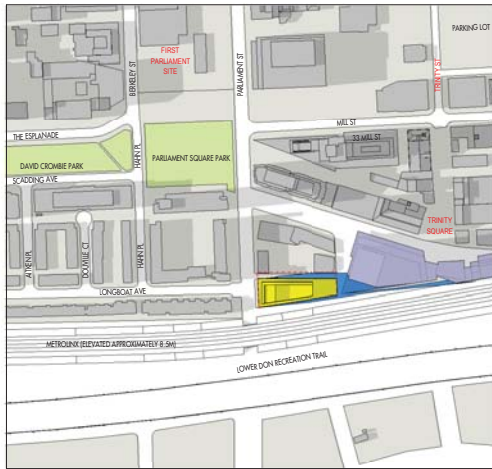

MARCH 21, 5:18PM

PROPOSED

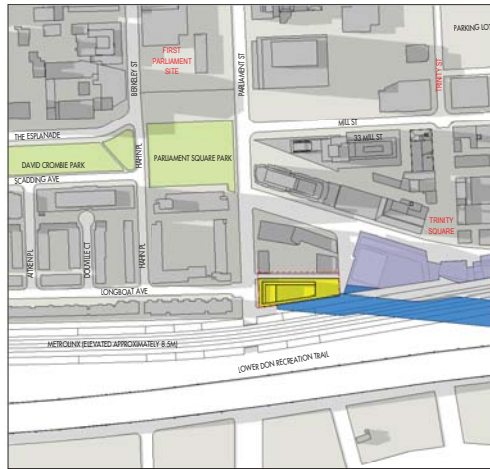

MARCH 21, 6:18PM

PROPOSED

LEGEND

EXISTING SHADOWS

PROJECT SITE

EXISTING PARKLAND

NET SHADOW IMPACT

PROPOSED DEVELOPMENTS

PREPARED FOR:
1150782 ONTARIO INC.
NOTE: WITHOUT PREJUDICE AND FOR SETTLEMENT PURPOSES ONLY

PROJECT:
**31 PARLIAMENT STREET
TORONTO, CANADA
37 STOREY OPTION**

DRAWING:
SHADOW STUDY - MARCH

PROJECT NORTH
TRUE NORTH

0 20 50 100 200 METERS
SCALE 1:5000
DATE: 4/12/2018 9:43:17 AM

ARQUITECTONICA

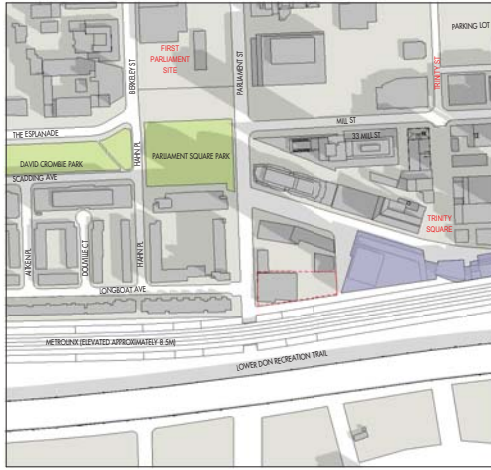

APRIL 21, 9:18AM

EXISTING

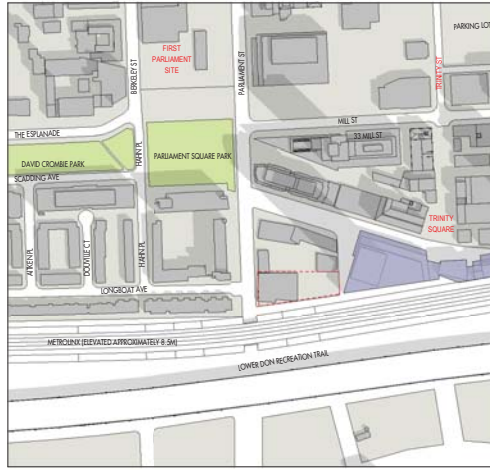

APRIL 21, 10:18AM

EXISTING

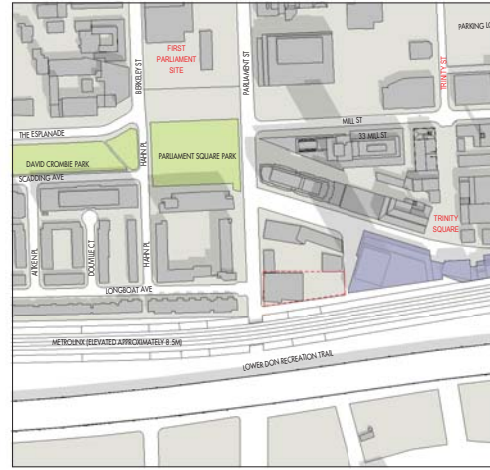

APRIL 21, 11:18AM

EXISTING

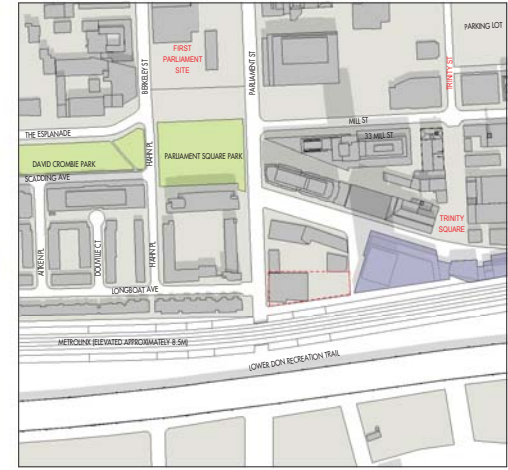

APRIL 21, 12:18PM

EXISTING

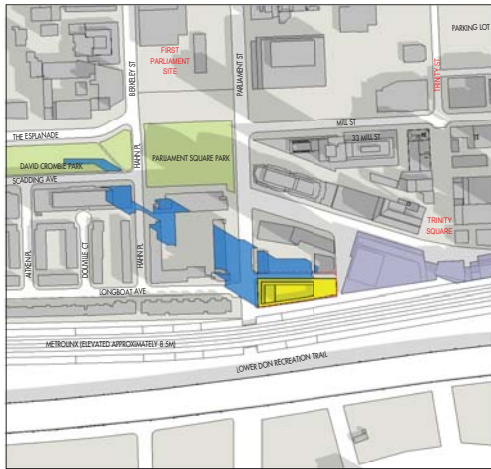

APRIL 21, 9:18AM

PROPOSED

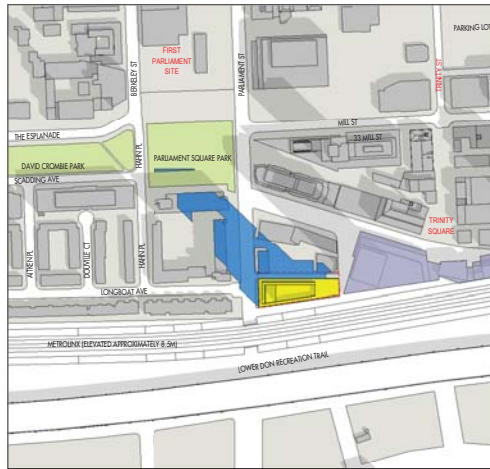

APRIL 21, 10:18AM

PROPOSED

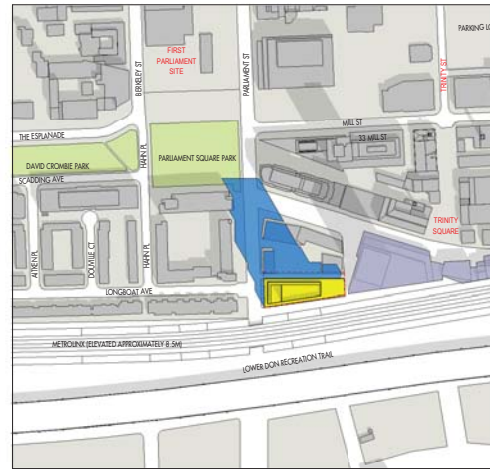

APRIL 21, 11:18AM

PROPOSED

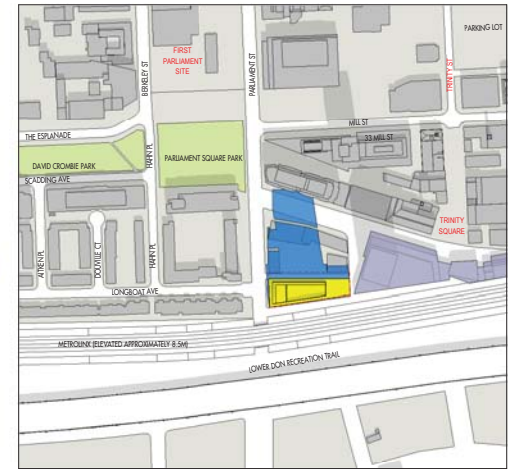

APRIL 21, 12:18PM

PROPOSED

LEGEND

EXISTING SHADOWS

PROJECT SITE

NET SHADOW IMPACT

EXISTING PARKLAND

PROPOSED DEVELOPMENTS

PREPARED FOR:
1150782 ONTARIO INC.
NOTE: WITHOUT PREJUDICE AND FOR SETTLEMENT PURPOSES ONLY

PROJECT:
**31 PARLIAMENT STREET
TORONTO, CANADA
37 STOREY OPTION**

DRAWING:
SHADOW STUDY - APRIL

PROJECT NORTH
TRUE NORTH

0 20 50 100 200 METERS
SCALE 1:5000
DATE: 4/12/2018 9:43:29 AM

ARQUITECTONICA

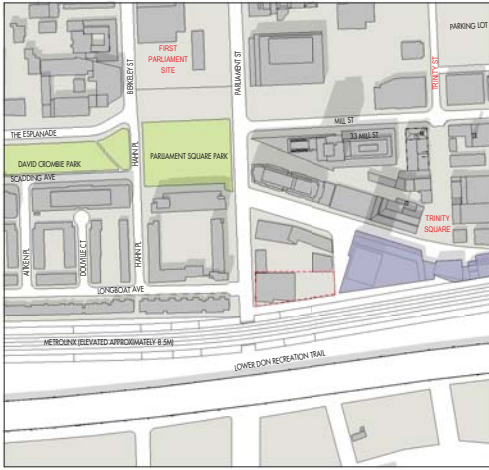

APRIL 21, 1:18PM

EXISTING

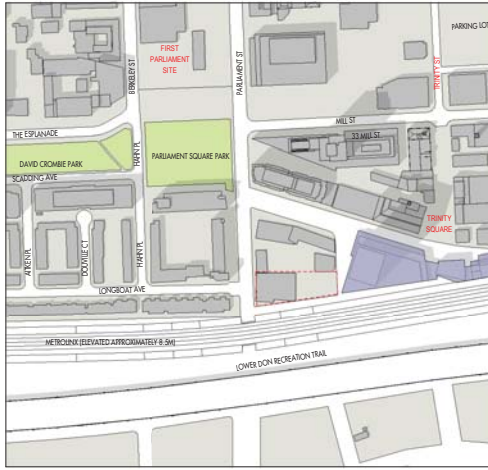

APRIL 21, 2:18PM

EXISTING

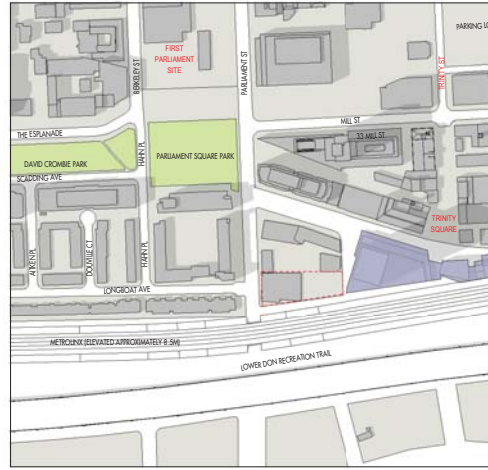

APRIL 21, 3:18PM

EXISTING

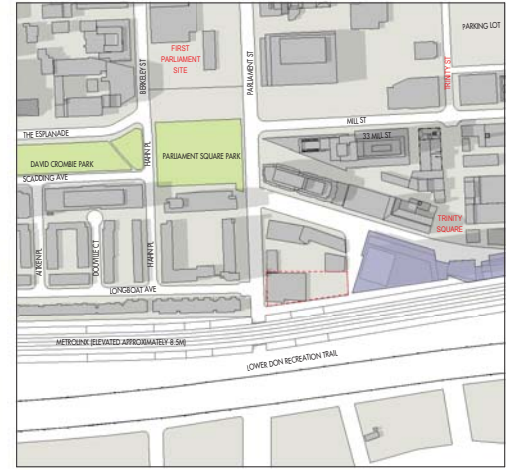

APRIL 21, 4:18PM

EXISTING

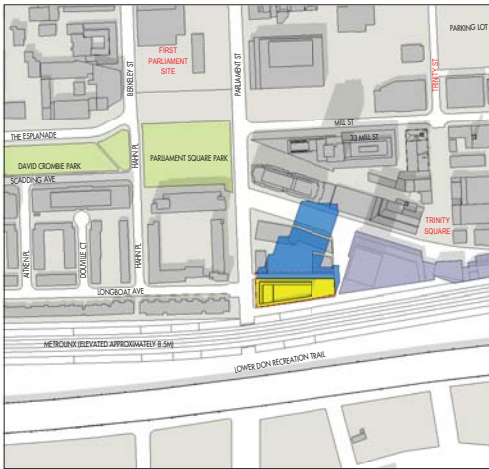

APRIL 21, 1:18PM

PROPOSED

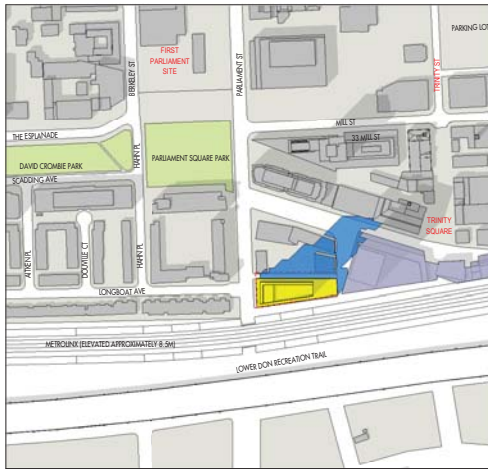

APRIL 21, 2:18PM

PROPOSED

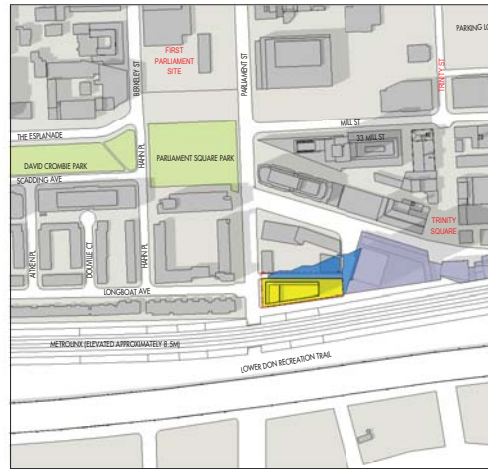

APRIL 21, 3:18PM

PROPOSED

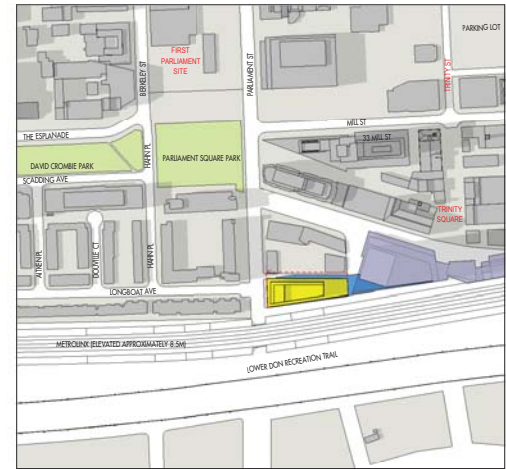

APRIL 21, 4:18PM

PROPOSED

LEGEND

EXISTING SHADOWS

PROJECT SITE

EXISTING PARKLAND

NET SHADOW IMPACT

PROPOSED DEVELOPMENTS

PREPARED FOR:
1150782 ONTARIO INC.
NOTE: WITHOUT PREJUDICE AND FOR SETTLEMENT PURPOSES ONLY

PROJECT:
**31 PARLIAMENT STREET
TORONTO, CANADA
37 STOREY OPTION**

DRAWING:
SHADOW STUDY - APRIL

PROJECT NORTH
TRUE NORTH

0 20 50 100 200 METERS
SCALE 1:5000
DATE: 4/12/2018 9:43:40 AM

ARQUITECTONICA

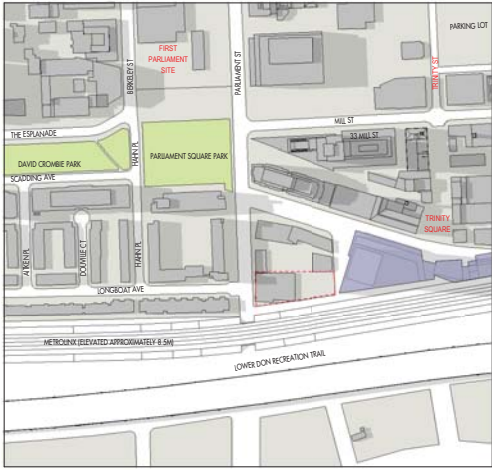

APRIL 21, 5:18PM

EXISTING

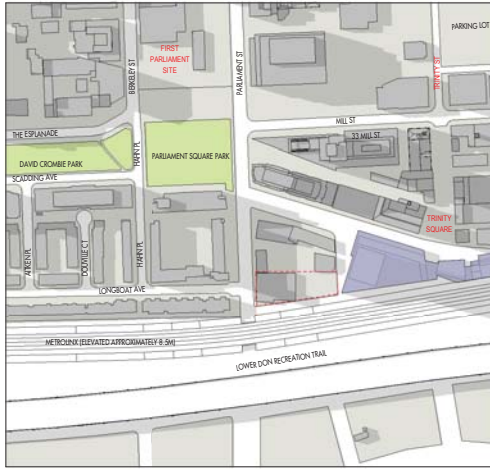

APRIL 21, 6:18PM

EXISTING

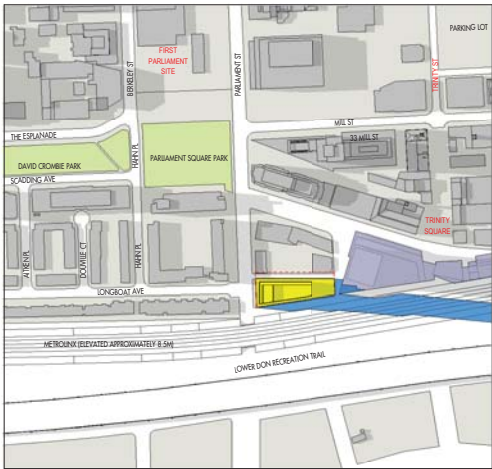

APRIL 21, 5:18PM

PROPOSED

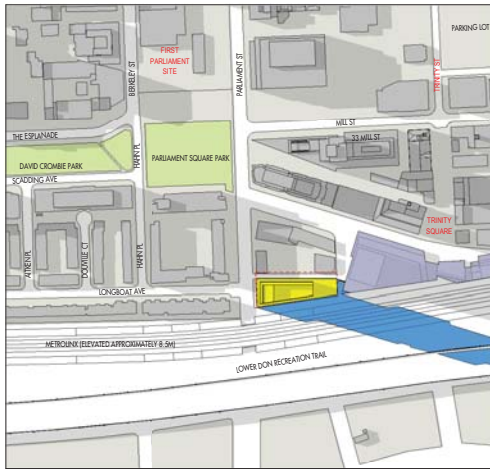

APRIL 21, 6:18PM

PROPOSED

LEGEND

EXISTING SHADOWS

PROJECT SITE

NET SHADOW IMPACT

EXISTING PARKLAND

PROPOSED DEVELOPMENTS

PREPARED FOR:
1150782 ONTARIO INC.
NOTE: WITHOUT PREJUDICE AND FOR SETTLEMENT PURPOSES ONLY

PROJECT:
**31 PARLIAMENT STREET
TORONTO, CANADA
37 STOREY OPTION**

DRAWING:
SHADOW STUDY - APRIL

PROJECT NORTH
TRUE NORTH

0 20 50 100 200 METERS
SCALE: 1:5000
DATE: 4/12/2018 9:43:46 AM

ARQUITECTONICA

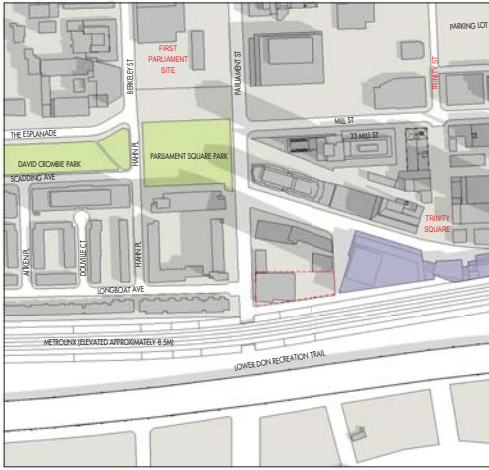

MAY 21, 9:18AM

EXISTING

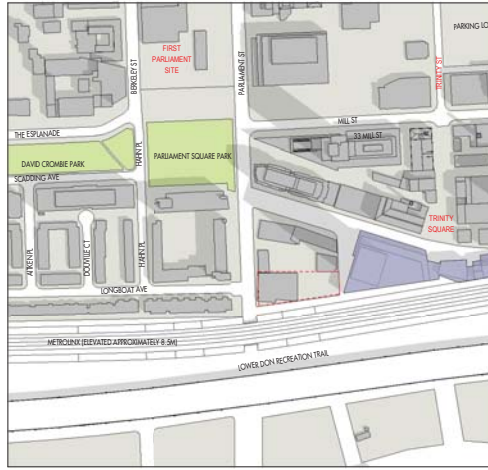

MAY 21, 10:18AM

EXISTING

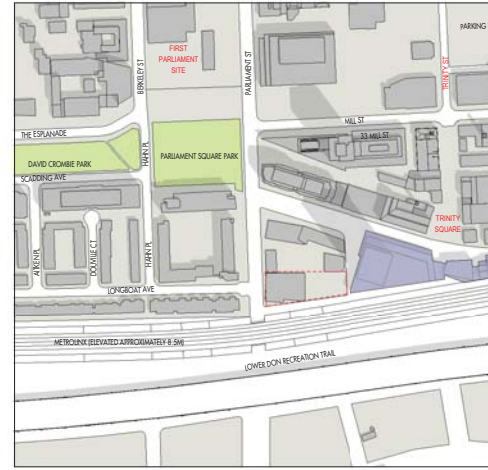

MAY 21, 11:18AM

EXISTING

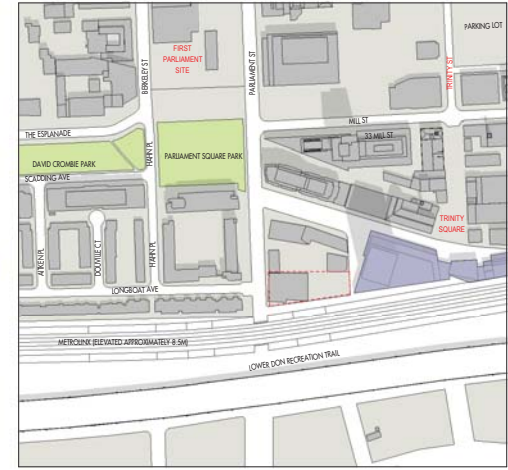

MAY 21, 12:18PM

EXISTING

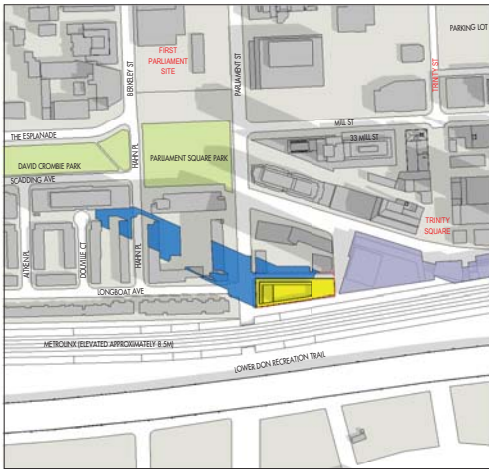

MAY 21, 9:18AM

PROPOSED

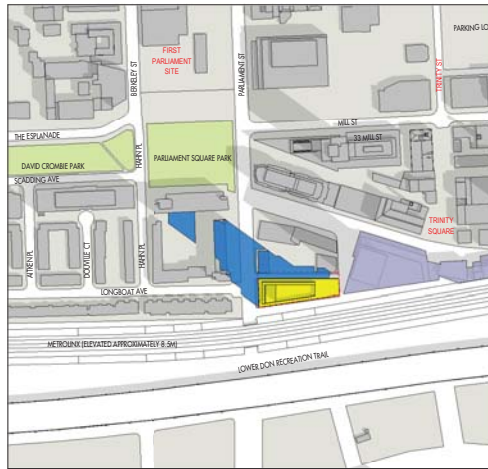

MAY 21, 10:18AM

PROPOSED

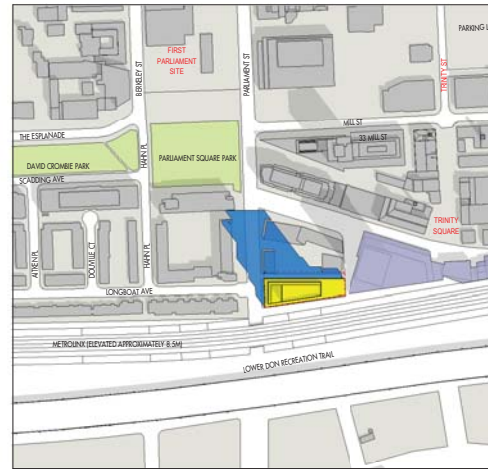

MAY 21, 11:18AM

PROPOSED

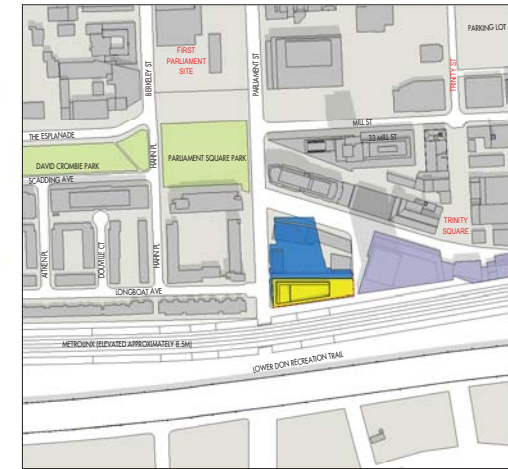

MAY 21, 12:18PM

PROPOSED

LEGEND

EXISTING SHADOWS

PROJECT SITE

NET SHADOW IMPACT

EXISTING PARKLAND

PROPOSED DEVELOPMENTS

PREPARED FOR:
1150782 ONTARIO INC.
NOTE: WITHOUT PREJUDICE AND FOR SETTLEMENT PURPOSES ONLY

PROJECT:
**31 PARLIAMENT STREET
TORONTO, CANADA
37 STOREY OPTION**

DRAWING:
SHADOW STUDY - MAY

PROJECT NORTH
TRUE NORTH

0 20 50 100 200 METERS

SCALE 1:5000
DATE: 4/12/2018 9:43:57 AM

ARQUITECTONICA

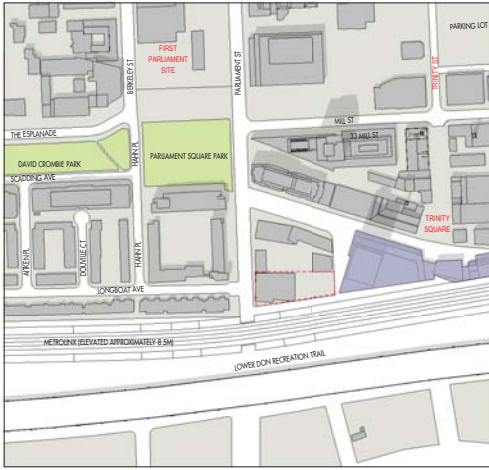

MAY 21, 1:18PM

EXISTING

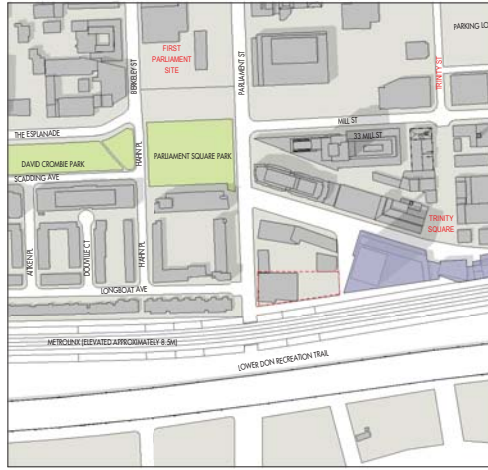

MAY 21, 2:18PM

EXISTING

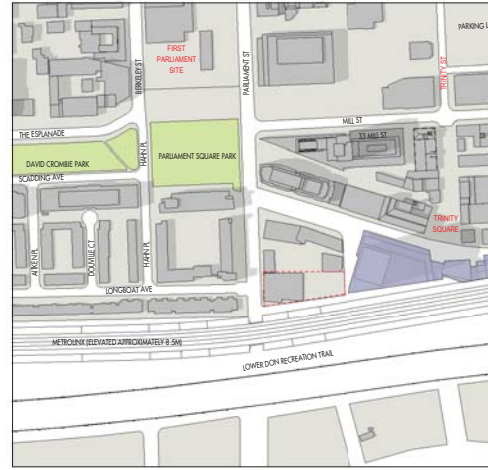

MAY 21, 3:18PM

EXISTING

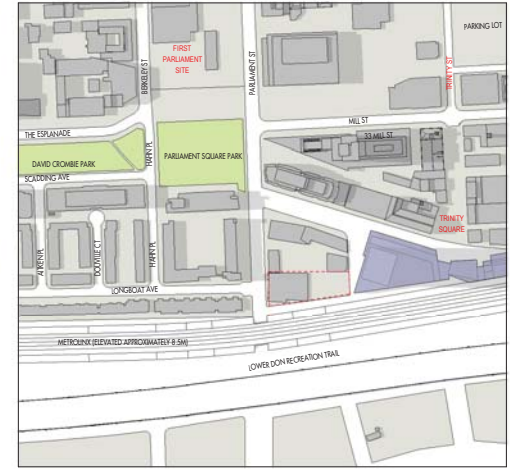

MAY 21, 4:18PM

EXISTING

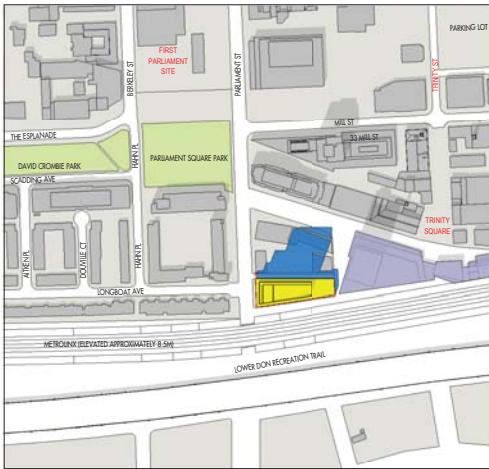

MAY 21, 1:18PM

PROPOSED

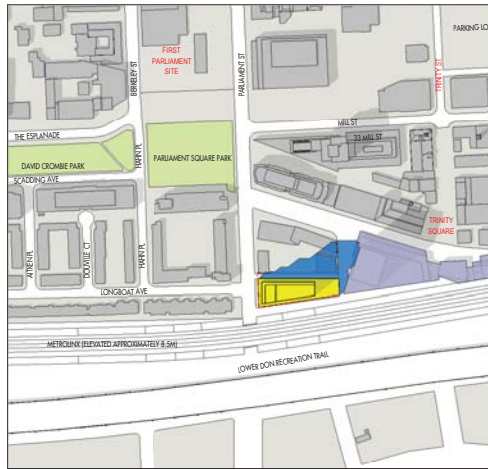

MAY 21, 2:18PM

PROPOSED

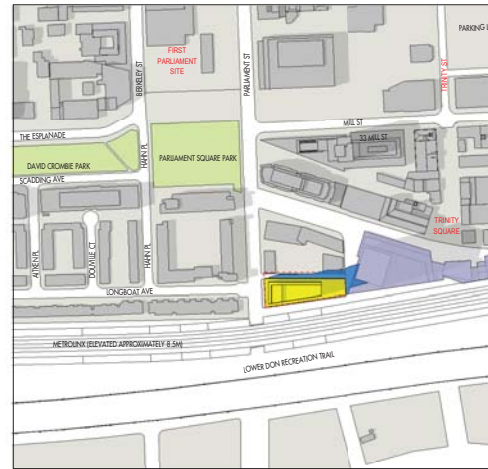

MAY 21, 3:18PM

PROPOSED

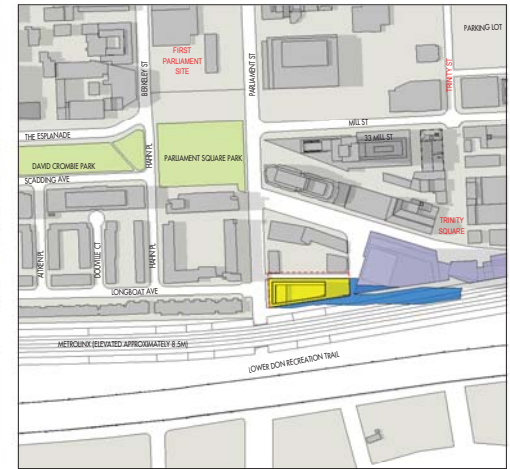

MAY 21, 4:18PM

PROPOSED

LEGEND

- PROJECT SITE
- NET SHADOW IMPACT
- EXISTING SHADOWS
- EXISTING PARKLAND
- PROPOSED DEVELOPMENTS

PREPARED FOR:
1150782 ONTARIO INC.
 NOTE: WITHOUT PREJUDICE AND FOR SETTLEMENT PURPOSES ONLY

PROJECT:
**31 PARLIAMENT STREET
 TORONTO, CANADA
 37 STOREY OPTION**

DRAWING:
SHADOW STUDY - MAY

ARQUITECTONICA

PROJECT NORTH
 TRUE NORTH
 0 20 50 100 200 METERS
 SCALE 1:5000
 DATE: 4/12/2018 9:44:08 AM

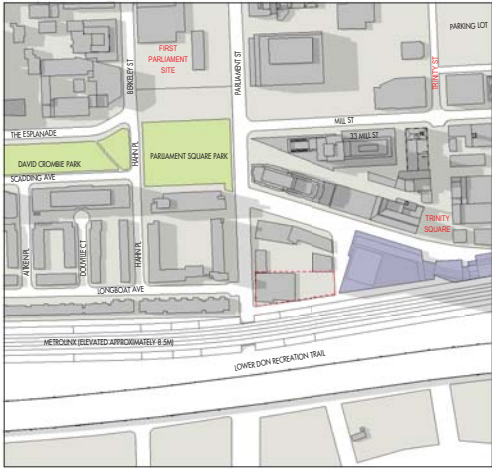

MAY 21, 5:18PM

EXISTING

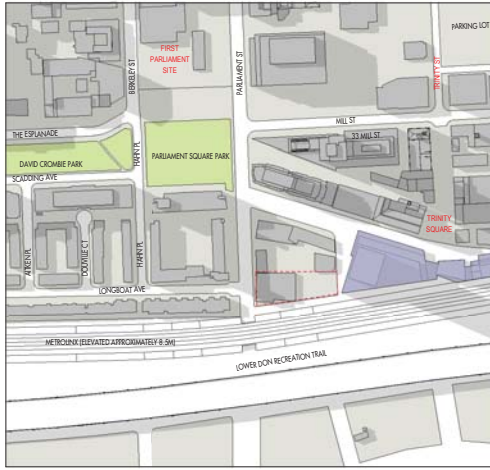

MAY 21, 6:18PM

EXISTING

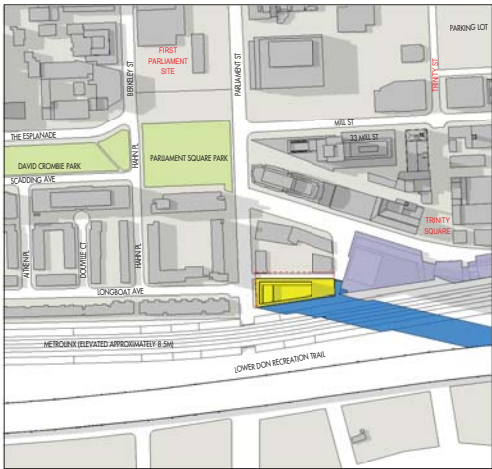

MAY 21, 5:18PM

PROPOSED

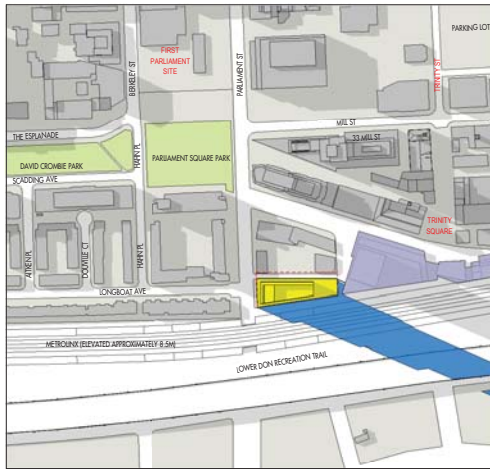

MAY 21, 6:18PM

PROPOSED

LEGEND

EXISTING SHADOWS

PROJECT SITE

NET SHADOW IMPACT

EXISTING PARKLAND

PROPOSED DEVELOPMENTS

PREPARED FOR:
1150782 ONTARIO INC.
NOTE: WITHOUT PREJUDICE AND FOR SETTLEMENT PURPOSES ONLY

PROJECT:
**31 PARLIAMENT STREET
TORONTO, CANADA
37 STOREY OPTION**

DRAWING:
SHADOW STUDY - MAY

PROJECT NORTH
 TRUE NORTH

0 20 50 100 200 METERS
SCALE 1:5000
DATE: 4/12/2018 9:44:14 AM

ARQUITECTONICA

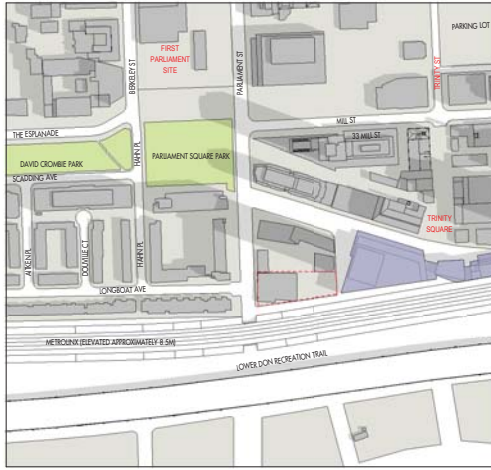

JUNE 21, 9:18AM

EXISTING

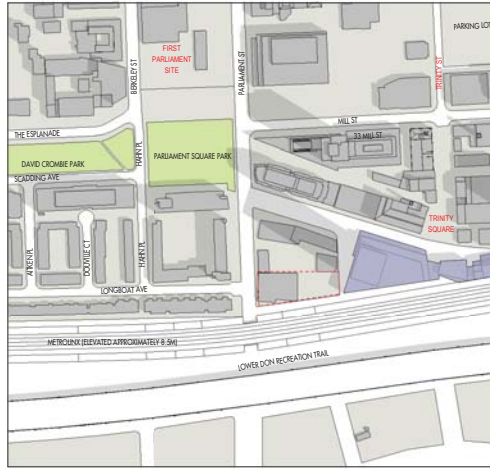

JUNE 21, 10:18AM

EXISTING

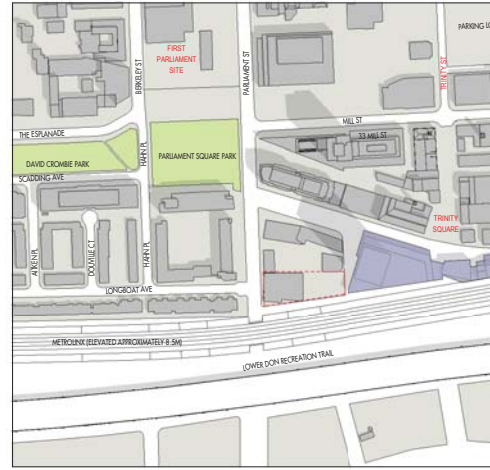

JUNE 21, 11:18AM

EXISTING

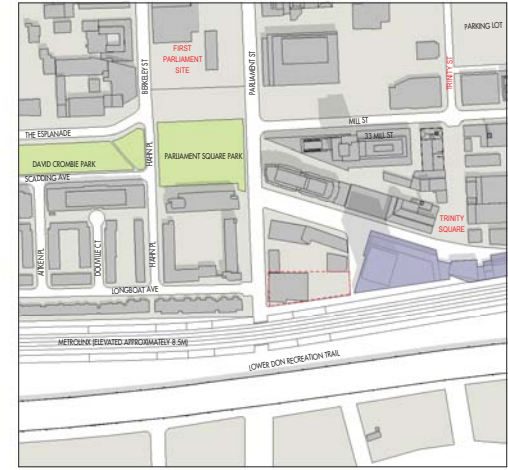

JUNE 21, 12:18PM

EXISTING

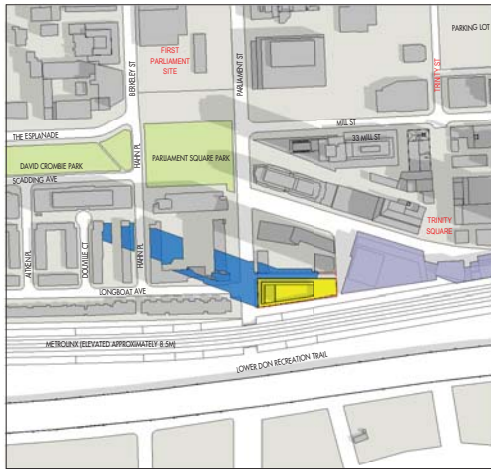

JUNE 21, 9:18AM

PROPOSED

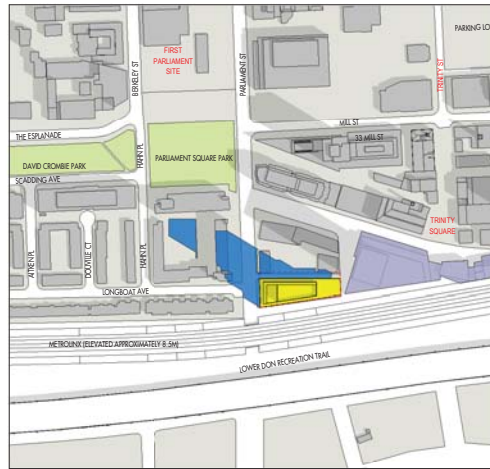

JUNE 21, 10:18AM

PROPOSED

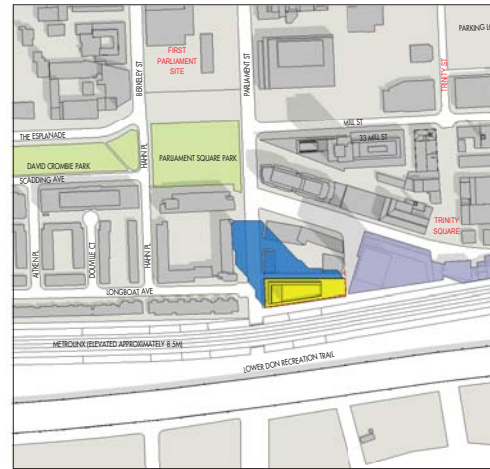

JUNE 21, 11:18AM

PROPOSED

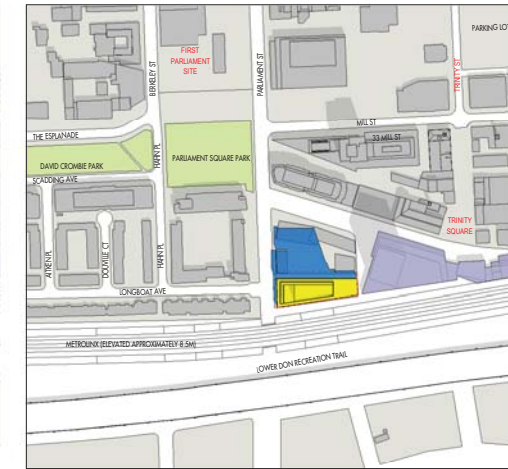

JUNE 21, 12:18PM

PROPOSED

LEGEND

- PROJECT SITE
- NET SHADOW IMPACT
- PROPOSED DEVELOPMENTS
- EXISTING SHADOWS
- EXISTING PARKLAND

PREPARED FOR:
1150782 ONTARIO INC.
 NOTE: WITHOUT PREJUDICE AND FOR SETTLEMENT PURPOSES ONLY

PROJECT:
31 PARLIAMENT STREET
TORONTO, CANADA
37 STOREY OPTION

DRAWING:
SHADOW STUDY - JUNE

PROJECT NORTH
 TRUE NORTH

0 20 50 100 200 METERS
 SCALE 1:5000
 DATE: 4/12/2018 9:44:25 AM

ARQUITECTONICA

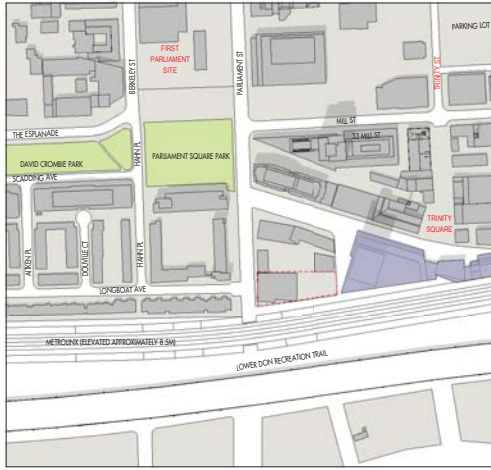

JUNE 21, 1:18PM

EXISTING

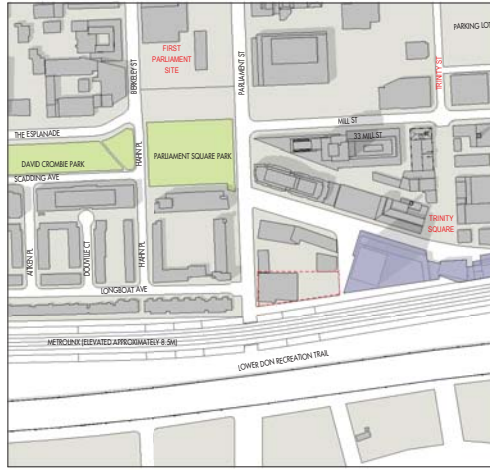

JUNE 21, 2:18PM

EXISTING

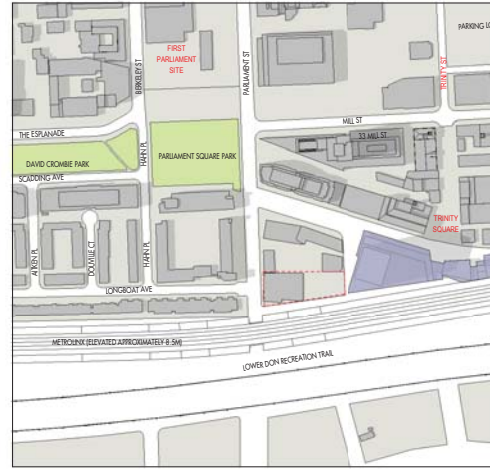

JUNE 21, 3:18PM

EXISTING

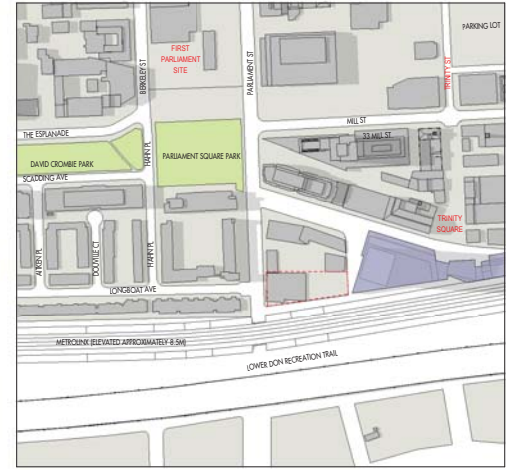

JUNE 21, 4:18PM

EXISTING

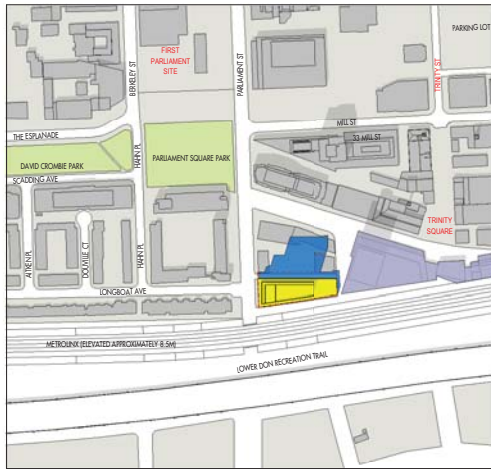

JUNE 21, 1:18PM

PROPOSED

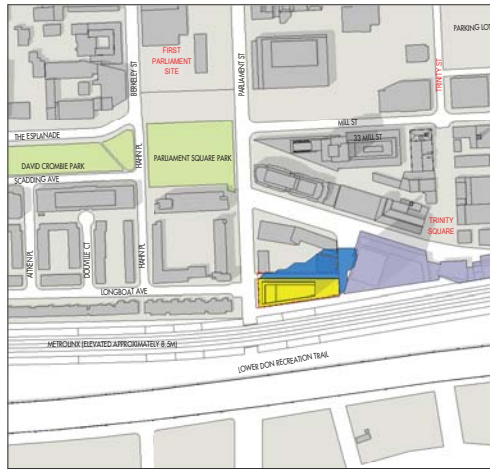

JUNE 21, 2:18PM

PROPOSED

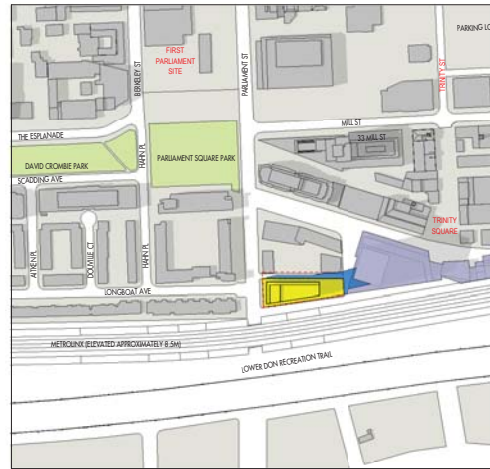

JUNE 21, 3:18PM

PROPOSED

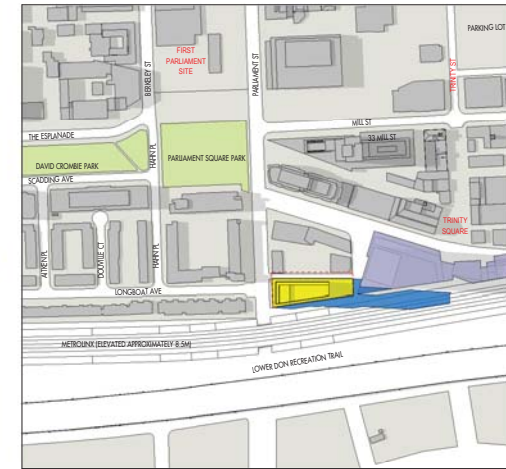

JUNE 21, 4:18PM

PROPOSED

LEGEND

EXISTING SHADOWS

PROJECT SITE

NET SHADOW IMPACT

EXISTING PARKLAND

PROPOSED DEVELOPMENTS

PREPARED FOR:
1150782 ONTARIO INC.
NOTE: WITHOUT PREJUDICE AND FOR SETTLEMENT PURPOSES ONLY

PROJECT:
**31 PARLIAMENT STREET
TORONTO, CANADA
37 STOREY OPTION**

DRAWING:
SHADOW STUDY - JUNE

PROJECT NORTH
 TRUE NORTH

0 20 50 100 200 METERS
SCALE 1:5000
DATE: 4/12/2018 9:44:36 AM

ARQUITECTONICA

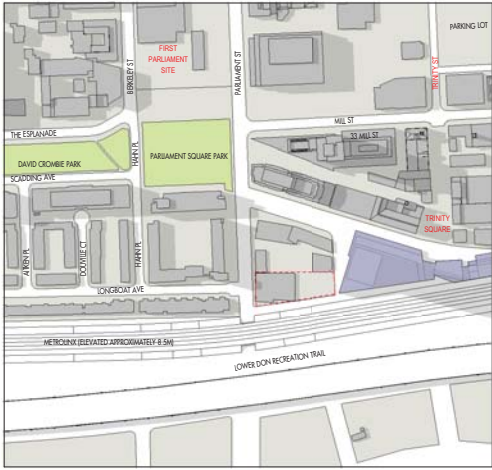

JUNE 21, 5:18PM

EXISTING

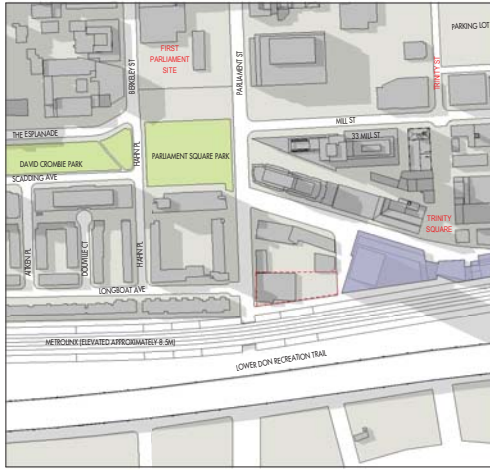

JUNE 21, 6:18PM

EXISTING

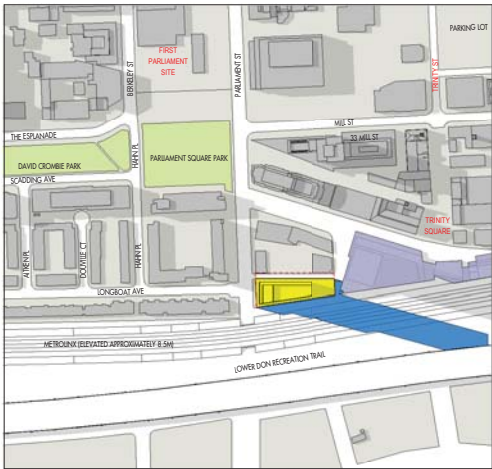

JUNE 21, 5:18PM

PROPOSED

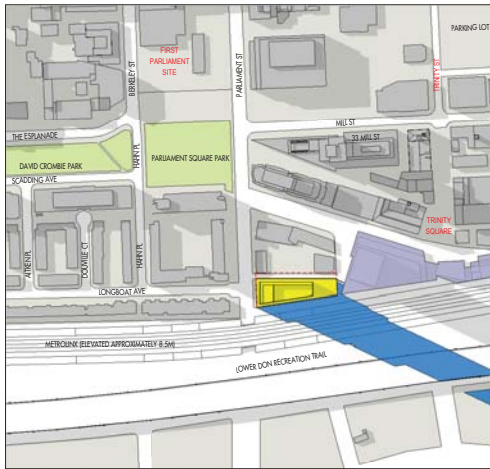

JUNE 21, 6:18PM

PROPOSED

LEGEND

EXISTING SHADOWS

PROJECT SITE

NET SHADOW IMPACT

EXISTING PARKLAND

PROPOSED DEVELOPMENTS

PREPARED FOR:
1150782 ONTARIO INC.
NOTE: WITHOUT PREJUDICE AND FOR SETTLEMENT PURPOSES ONLY

PROJECT:
**31 PARLIAMENT STREET
TORONTO, CANADA
37 STOREY OPTION**

DRAWING:
SHADOW STUDY - JUNE

PROJECT NORTH
TRUE NORTH

0 20 50 100 200 METERS
SCALE 1:5000
DATE: 4/12/2018 9:44:42 AM

ARQUITECTONICA

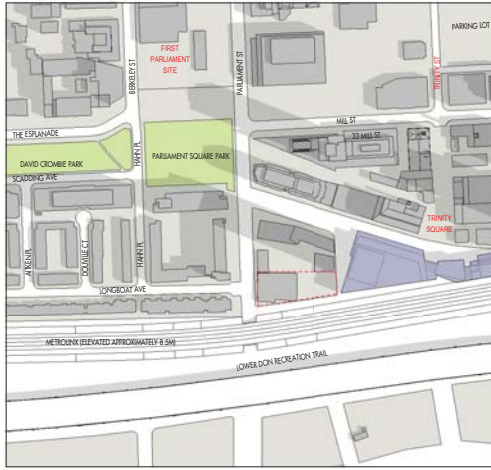

JULY 21, 9:18AM

EXISTING

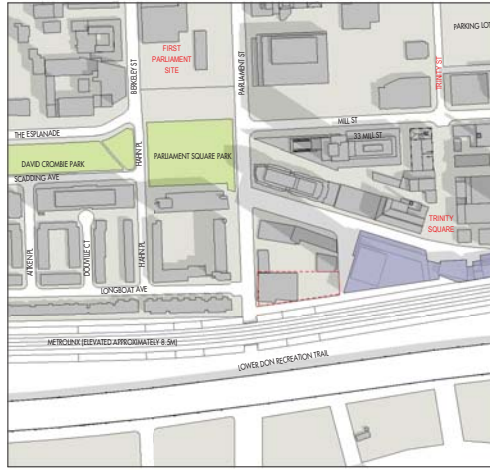

JULY 21, 10:18AM

EXISTING

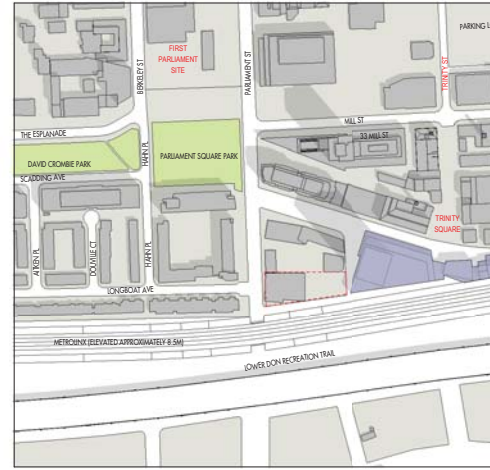

JULY 21, 11:18AM

EXISTING

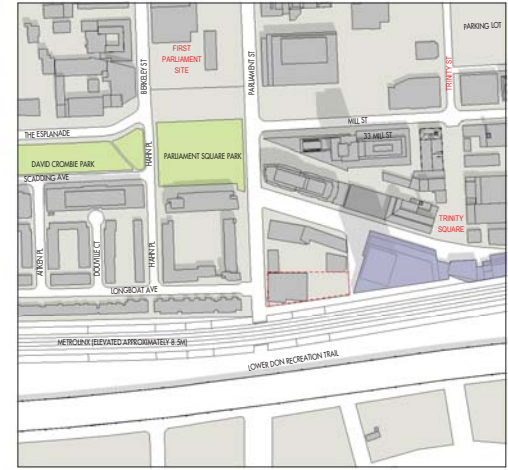

JULY 21, 12:18PM

EXISTING

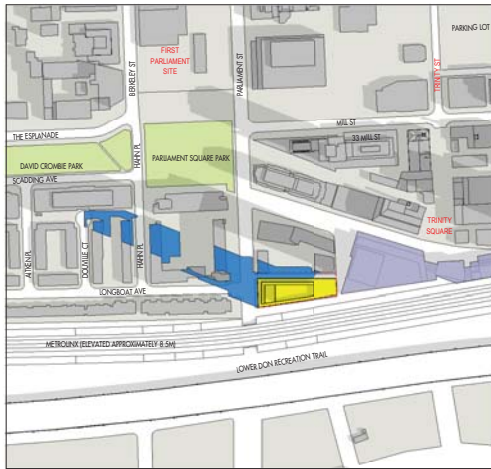

JULY 21, 9:18AM

PROPOSED

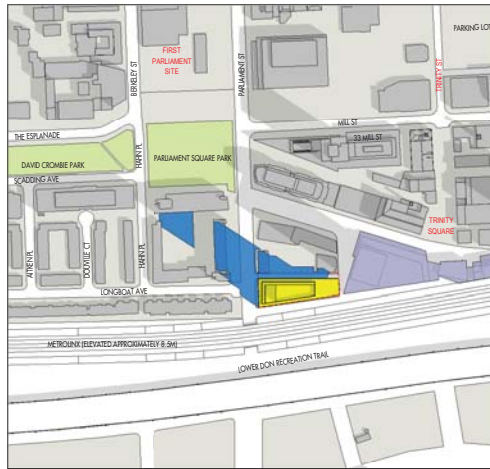

JULY 21, 10:18AM

PROPOSED

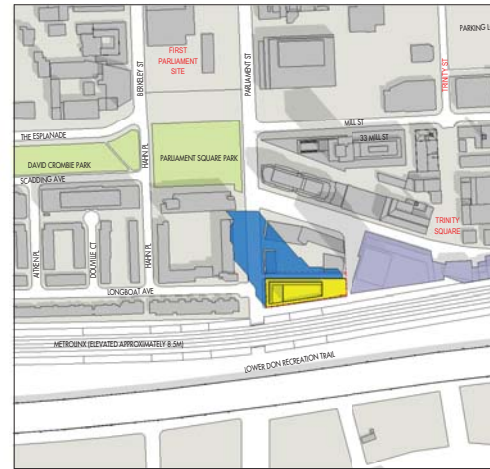

JULY 21, 11:18AM

PROPOSED

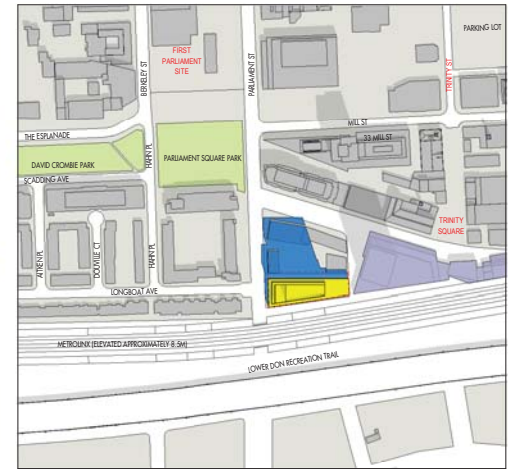

JULY 21, 12:18PM

PROPOSED

LEGEND

- PROJECT SITE
- NET SHADOW IMPACT
- EXISTING SHADOWS
- EXISTING PARKLAND
- PROPOSED DEVELOPMENTS

PREPARED FOR:
1150782 ONTARIO INC.
 NOTE: WITHOUT PREJUDICE AND FOR SETTLEMENT PURPOSES ONLY

PROJECT:
31 PARLIAMENT STREET
TORONTO, CANADA
37 STOREY OPTION

DRAWING:
SHADOW STUDY - JULY

ARQUITECTONICA

PROJECT NORTH

TRUE NORTH

SCALE 1:5000

DATE: 4/12/2018 9:44:52 AM

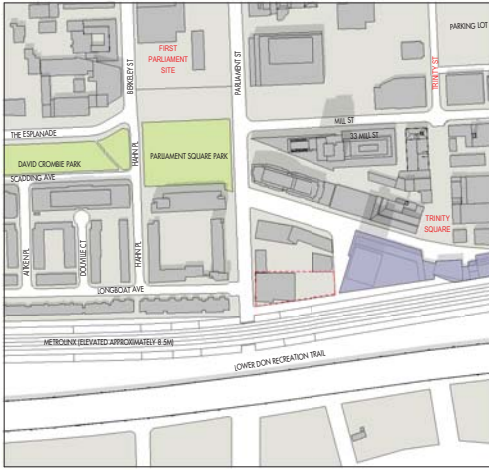

JULY 21, 1:18PM

EXISTING

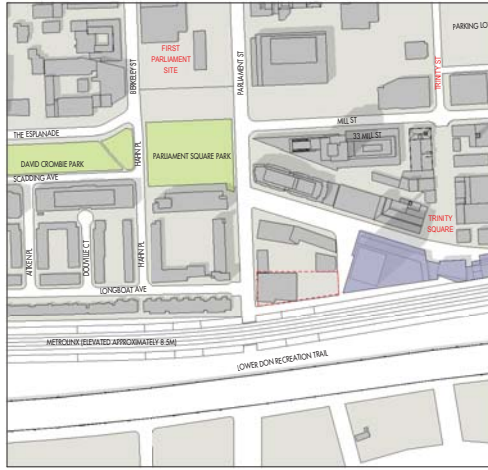

JULY 21, 2:18PM

EXISTING

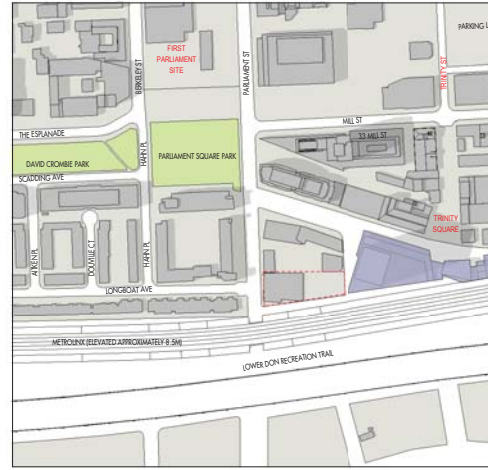

JULY 21, 3:18PM

EXISTING

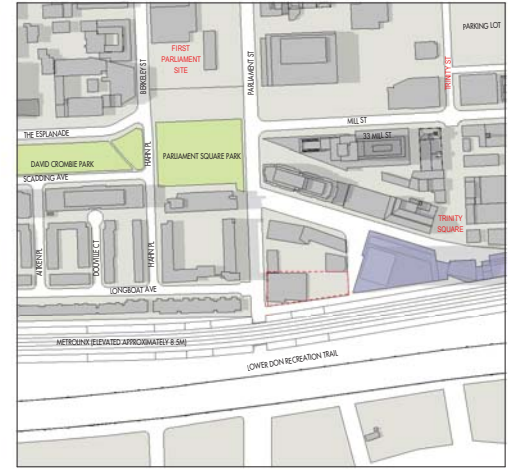

JULY 21, 4:18PM

EXISTING

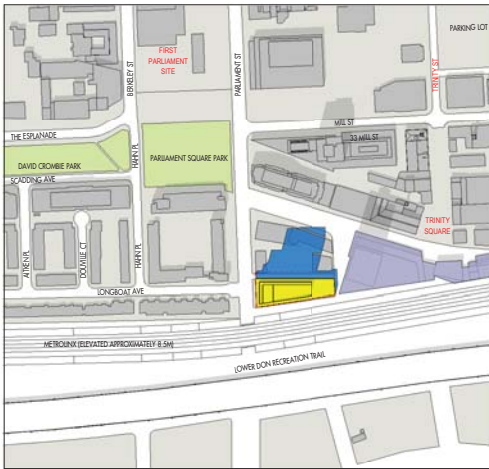

JULY 21, 1:18PM

PROPOSED

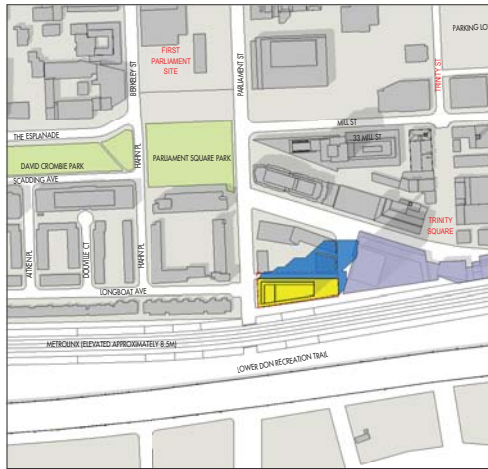

JULY 21, 2:18PM

PROPOSED

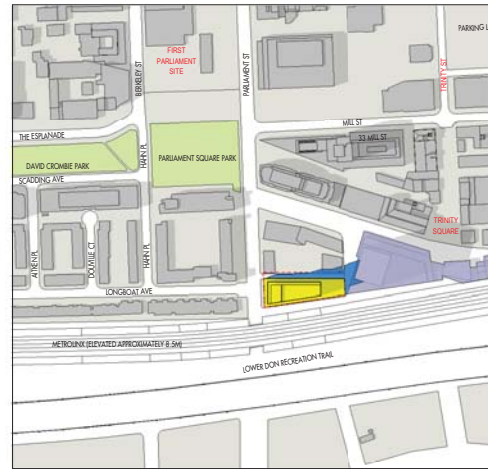

JULY 21, 3:18PM

PROPOSED

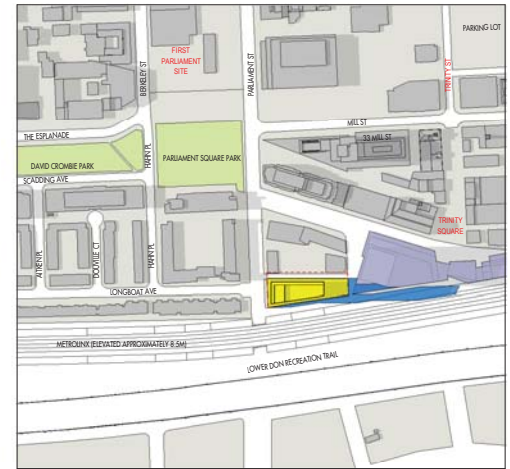

JULY 21, 4:18PM

PROPOSED

LEGEND

EXISTING SHADOWS

PROJECT SITE

NET SHADOW IMPACT

EXISTING PARKLAND

PROPOSED DEVELOPMENTS

PREPARED FOR:
1150782 ONTARIO INC.
NOTE: WITHOUT PREJUDICE AND FOR SETTLEMENT PURPOSES ONLY

PROJECT:
**31 PARLIAMENT STREET
TORONTO, CANADA
37 STOREY OPTION**

DRAWING:
SHADOW STUDY- JULY

PROJECT NORTH
TRUE NORTH

0 20 50 100 200 METERS
SCALE 1:5000
DATE: 4/12/2018 9:45:03 AM

ARQUITECTONICA

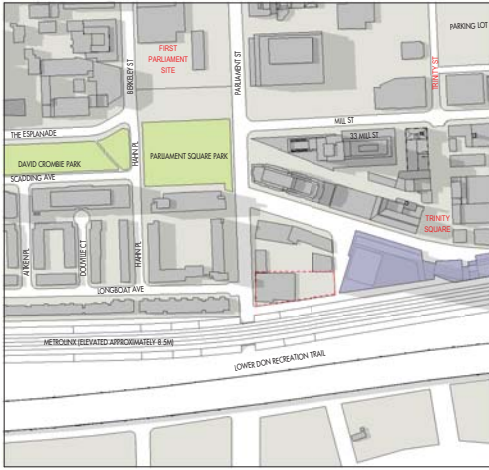

JULY 21, 5:18PM

EXISTING

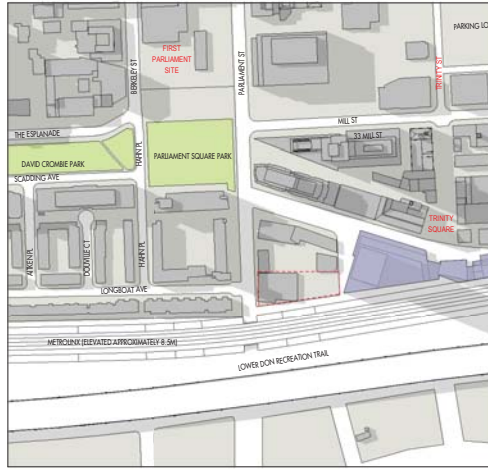

JULY 21, 6:18PM

EXISTING

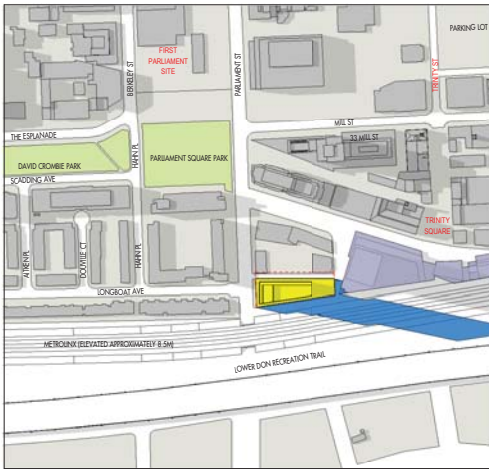

JULY 21, 5:18PM

PROPOSED

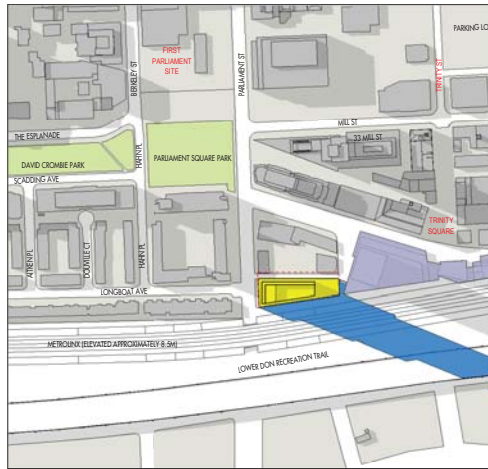

JULY 21, 6:18PM

PROPOSED

LEGEND

EXISTING SHADOWS

PROJECT SITE

NET SHADOW IMPACT

EXISTING PARKLAND

PROPOSED DEVELOPMENTS

PREPARED FOR:
1150782 ONTARIO INC.
NOTE: WITHOUT PREJUDICE AND FOR SETTLEMENT PURPOSES ONLY

PROJECT:
**31 PARLIAMENT STREET
TORONTO, CANADA
37 STOREY OPTION**

DRAWING:
SHADOW STUDY - JULY

PROJECT NORTH
TRUE NORTH

0 20 50 100 200 METERS
SCALE 1:5000
DATE: 4/12/2018 9:45:10 AM

ARQUITECTONICA

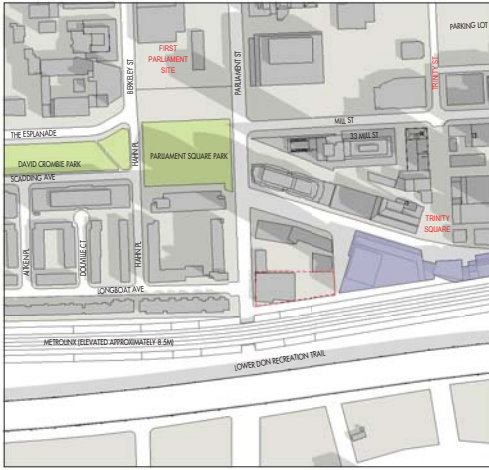

AUGUST 21, 9:18AM

EXISTING

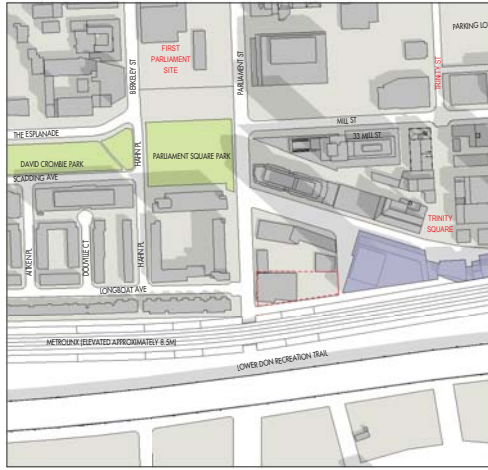

AUGUST 21, 10:18AM

EXISTING

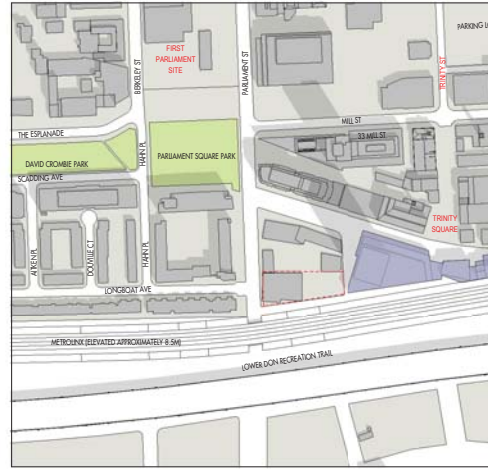

AUGUST 21, 11:18AM

EXISTING

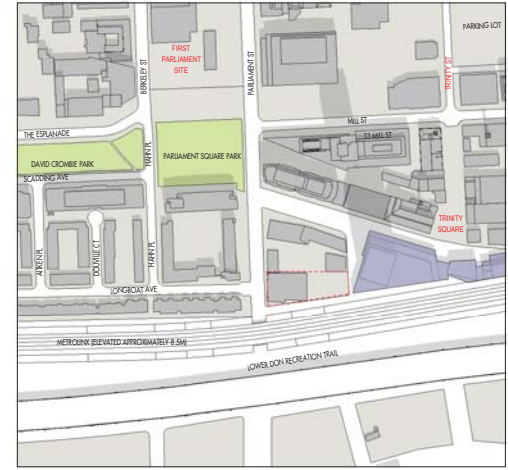

AUGUST 21, 12:18PM

EXISTING

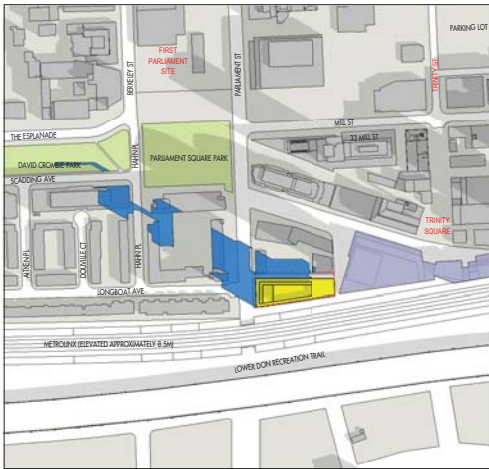

AUGUST 21, 9:18AM

PROPOSED

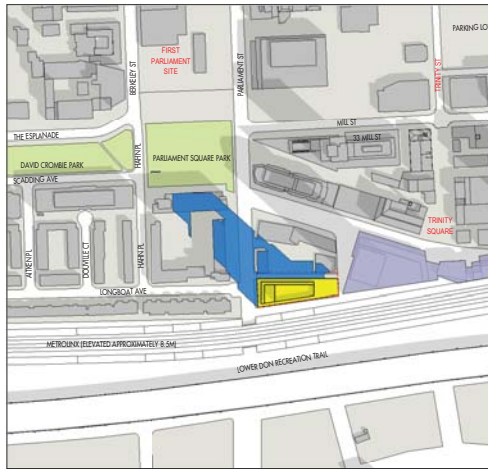

AUGUST 21, 10:18AM

PROPOSED

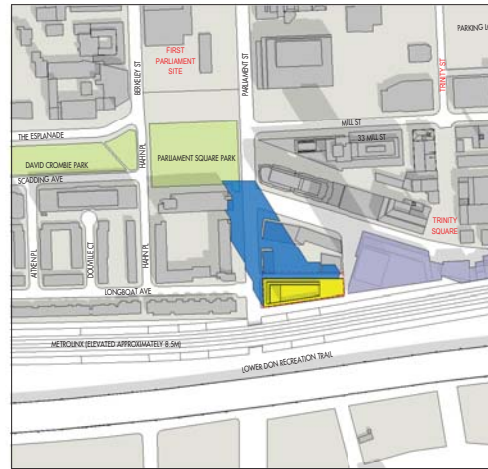

AUGUST 21, 11:18AM

PROPOSED

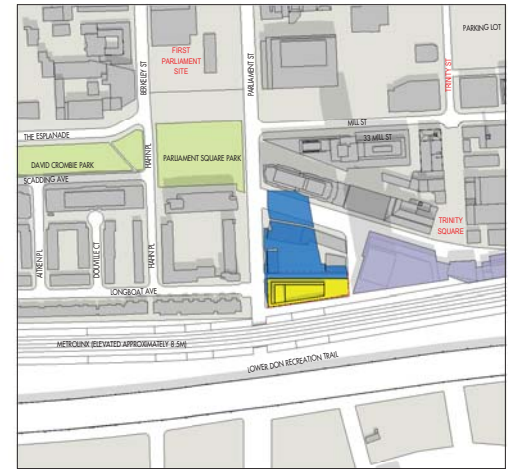

AUGUST 21, 12:18PM

PROPOSED

LEGEND

EXISTING SHADOWS

PROJECT SITE

EXISTING PARKLAND

NET SHADOW IMPACT

PROPOSED DEVELOPMENTS

PREPARED FOR:
1150782 ONTARIO INC.
NOTE: WITHOUT PREJUDICE AND FOR SETTLEMENT PURPOSES ONLY

PROJECT:
**31 PARLIAMENT STREET
TORONTO, CANADA
37 STOREY OPTION**

DRAWING:
SHADOW STUDY - AUGUST

PROJECT NORTH
TRUE NORTH

0 20 50 100 200 METERS
SCALE 1:5000
DATE: 4/12/2018 9:45:21 AM

ARQUITECTONICA

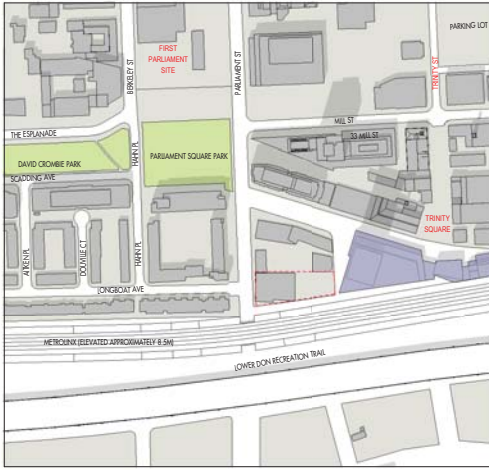

AUGUST 21, 1:18PM

EXISTING

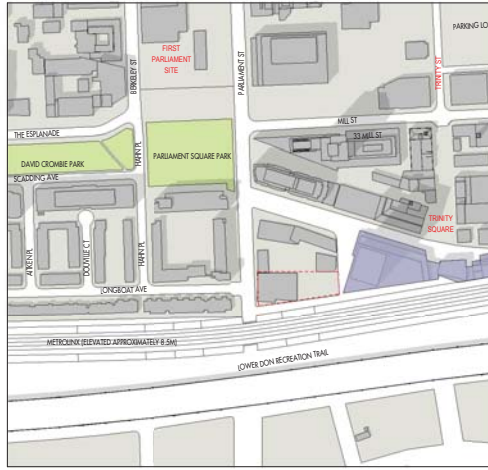

AUGUST 21, 2:18PM

EXISTING

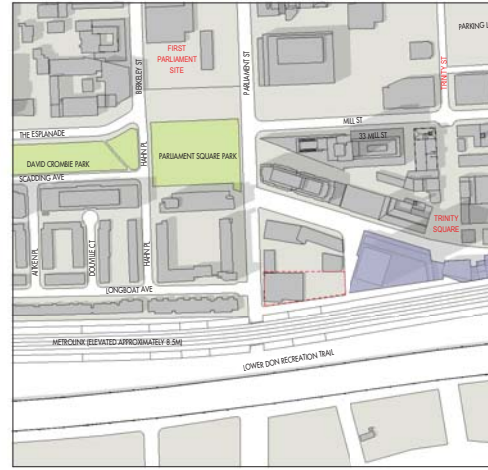

AUGUST 21, 3:18PM

EXISTING

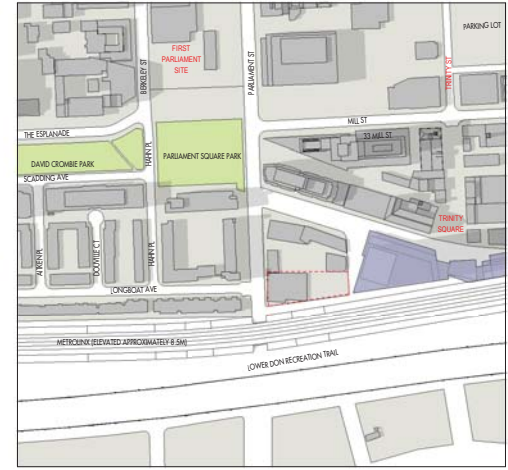

AUGUST 21, 4:18PM

EXISTING

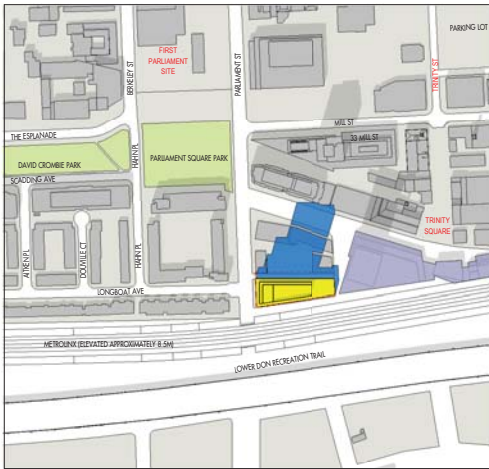

AUGUST 21, 1:18PM

PROPOSED

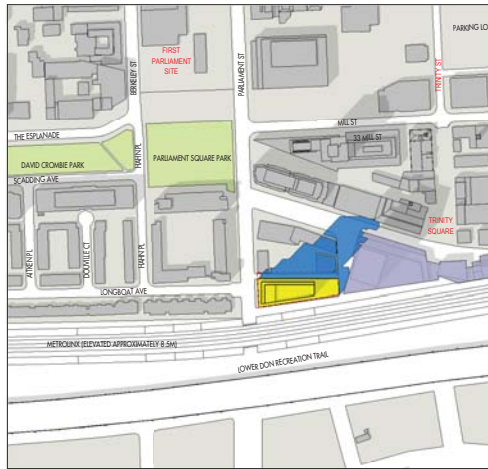

AUGUST 21, 2:18PM

PROPOSED

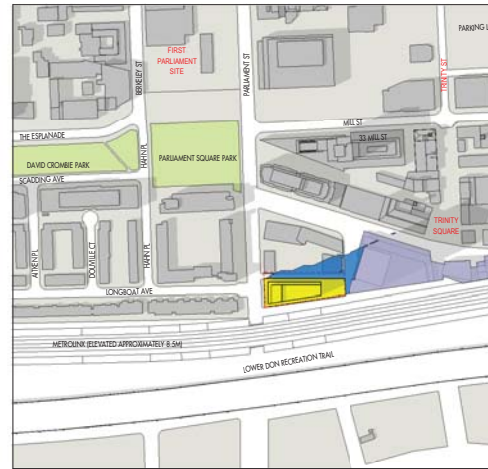

AUGUST 21, 3:18PM

PROPOSED

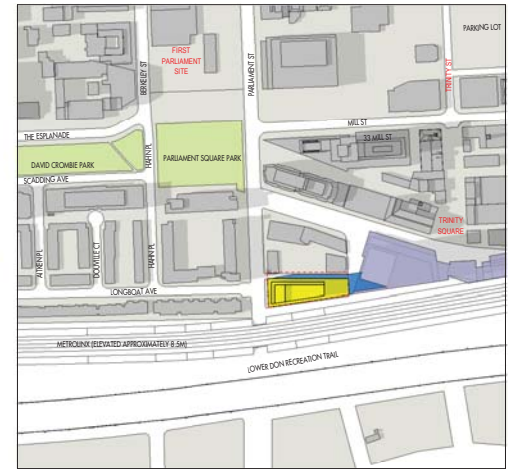

AUGUST 21, 4:18PM

PROPOSED

LEGEND

- PROJECT SITE
- NET SHADOW IMPACT
- EXISTING SHADOWS
- EXISTING PARKLAND
- PROPOSED DEVELOPMENTS

PREPARED FOR:
1150782 ONTARIO INC.
 NOTE: WITHOUT PREJUDICE AND FOR SETTLEMENT PURPOSES ONLY

PROJECT:
**31 PARLIAMENT STREET
 TORONTO, CANADA
 37 STOREY OPTION**

DRAWING:
SHADOW STUDY - AUGUST

ARQUITECTONICA

PROJECT NORTH
 TRUE NORTH
 0 20 50 100 200 METERS
 SCALE 1:5000
 DATE: 4/12/2018 9:45:32 AM

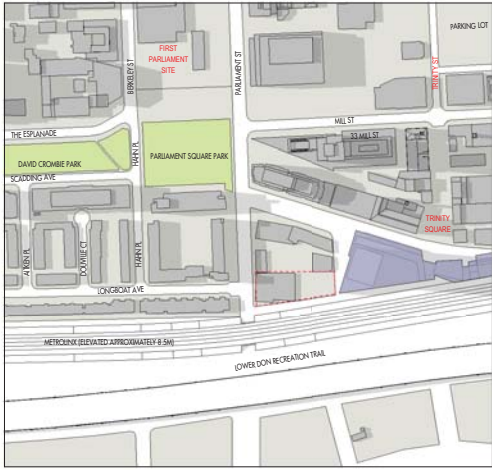

AUGUST 21, 5:18PM

EXISTING

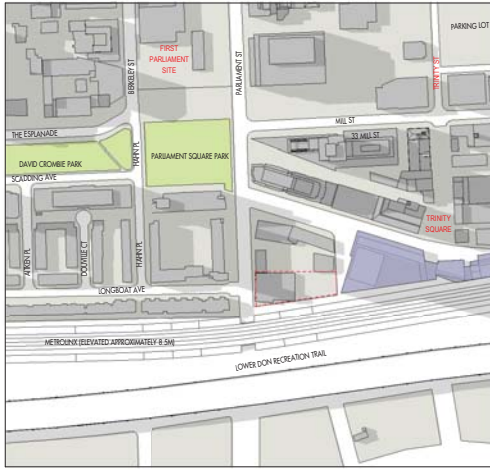

AUGUST 21, 6:18PM

EXISTING

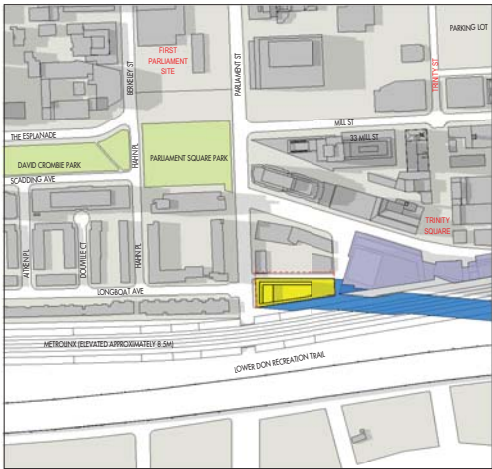

AUGUST 21, 5:18PM

PROPOSED

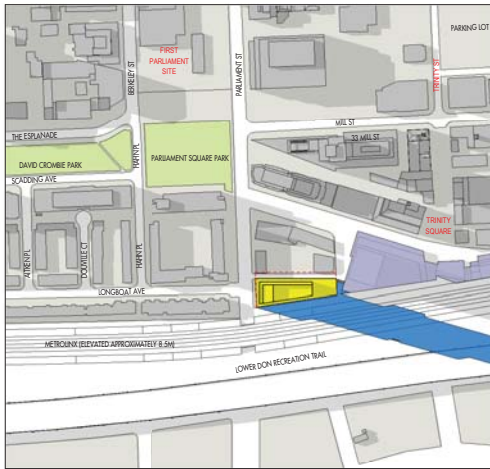

AUGUST 21, 6:18PM

PROPOSED

LEGEND

EXISTING SHADOWS



PROJECT SITE



NET SHADOW IMPACT



EXISTING PARKLAND



PROPOSED DEVELOPMENTS

PREPARED FOR:
1150782 ONTARIO INC.
NOTE: WITHOUT PREJUDICE AND FOR SETTLEMENT PURPOSES ONLY

PROJECT:
**31 PARLIAMENT STREET
TORONTO, CANADA
37 STOREY OPTION**

DRAWING:
SHADOW STUDY - AUGUST

PROJECT NORTH
TRUE NORTH

0 20 50 100 200 METERS
SCALE 1:5000
DATE: 4/12/2018 9:45:38 AM

ARQUITECTONICA

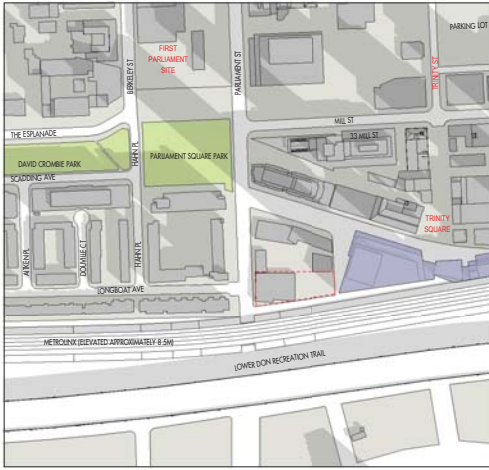

SEPTEMBER 21, 9:18AM

EXISTING

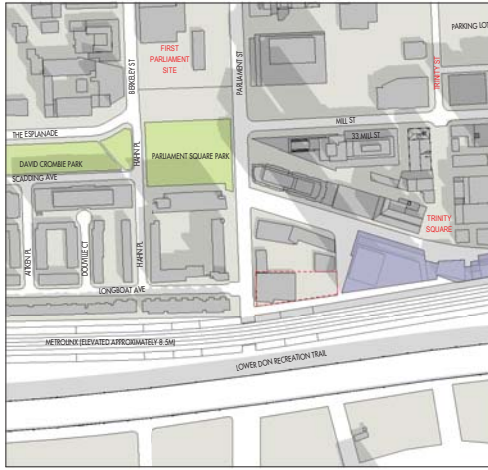

SEPTEMBER 21, 10:18AM

EXISTING

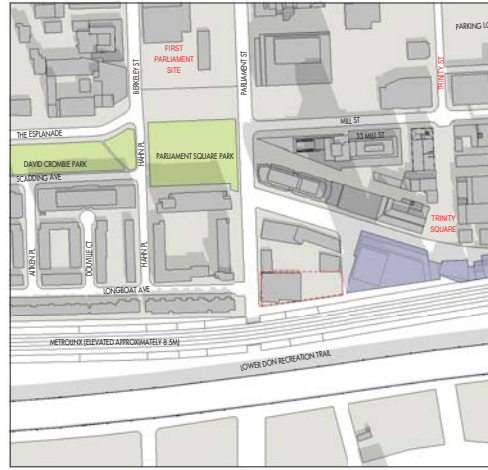

SEPTEMBER 21, 11:18AM

EXISTING

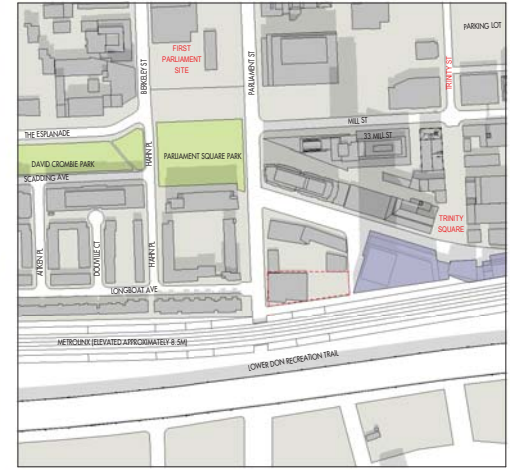

SEPTEMBER 21, 12:18PM

EXISTING

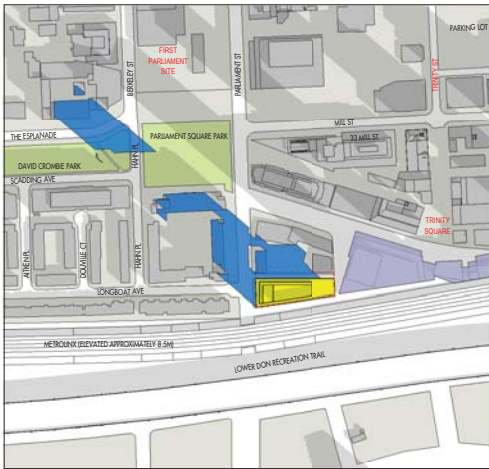

SEPTEMBER 21, 9:18AM

PROPOSED

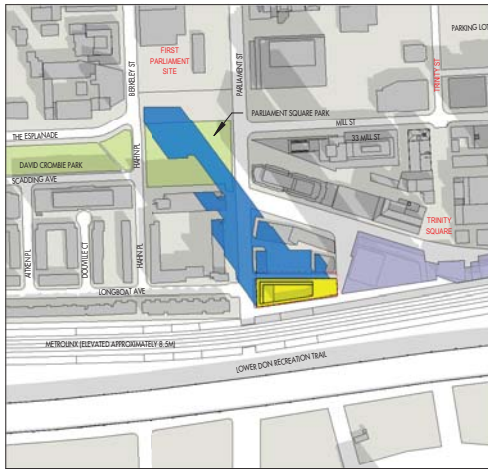

SEPTEMBER 21, 10:18AM

PROPOSED

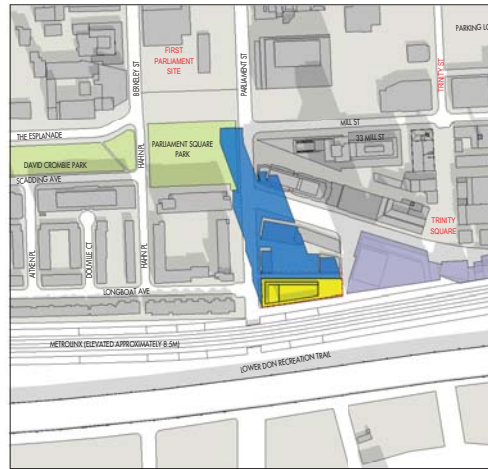

SEPTEMBER 21, 11:18AM

PROPOSED

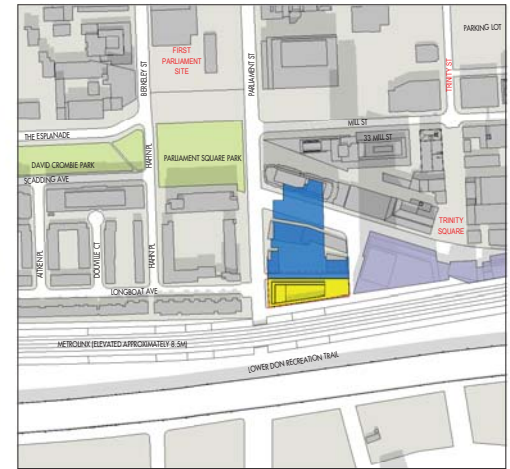

SEPTEMBER 21, 12:18PM

PROPOSED

LEGEND

EXISTING SHADOWS

PROJECT SITE

EXISTING PARKLAND

NET SHADOW IMPACT

PROPOSED DEVELOPMENTS

PREPARED FOR:
1150782 ONTARIO INC.
NOTE: WITHOUT PREJUDICE AND FOR SETTLEMENT PURPOSES ONLY

PROJECT:
**31 PARLIAMENT STREET
TORONTO, CANADA
37 STOREY OPTION**

DRAWING:
SHADOW STUDY - SEPTEMBER

PROJECT NORTH
TRUE NORTH

0 20 50 100 200 METERS

SCALE 1:5000
DATE: 4/12/2018 9:45:49 AM

ARQUITECTONICA

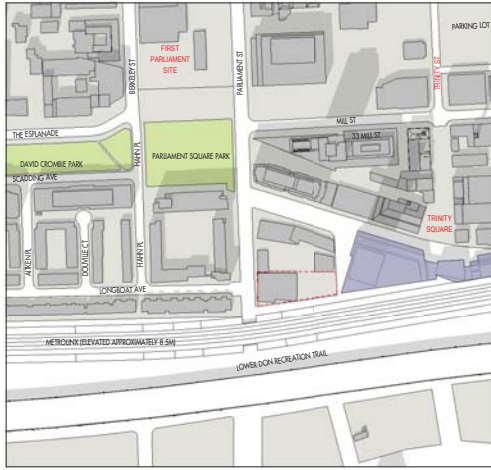

SEPTEMBER 21, 1:18PM

EXISTING

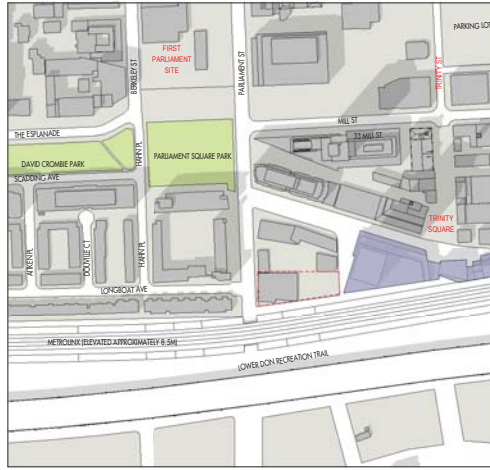

SEPTEMBER 21, 2:18PM

EXISTING

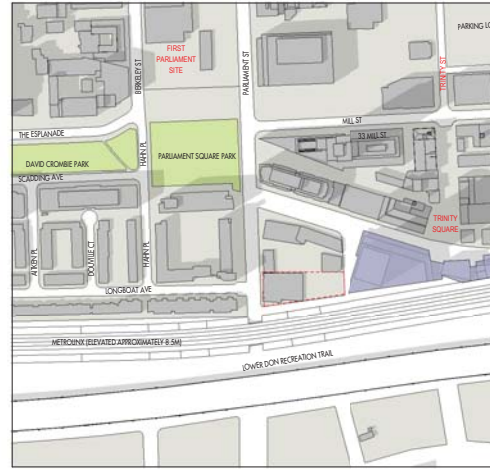

SEPTEMBER 21, 3:18PM

EXISTING

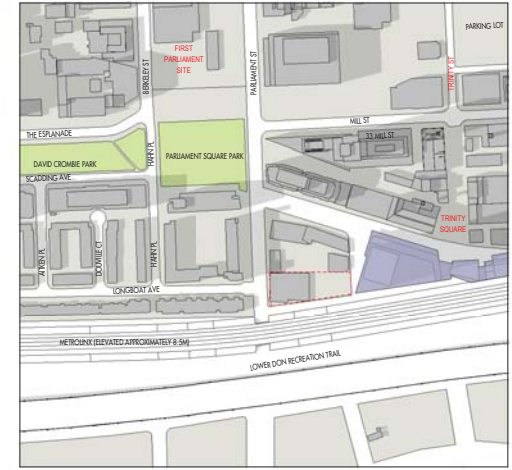

SEPTEMBER 21, 4:18PM

EXISTING

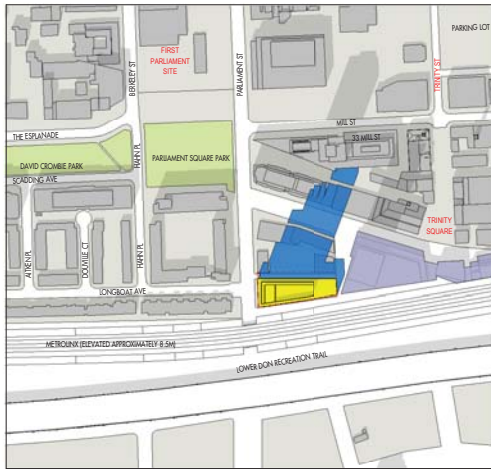

SEPTEMBER 21, 1:18PM

PROPOSED

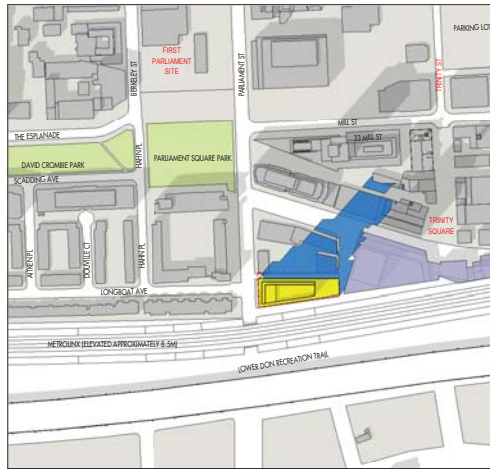

SEPTEMBER 21, 2:18PM

PROPOSED

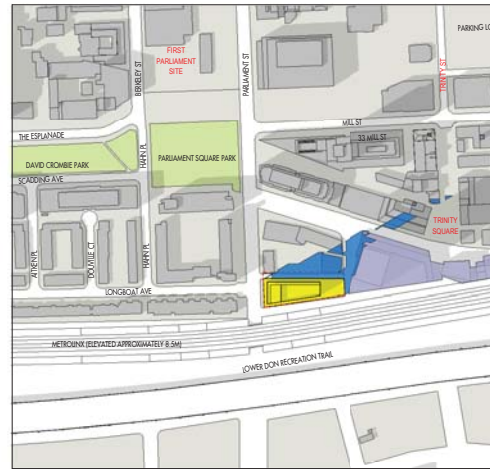

SEPTEMBER 21, 3:18PM

PROPOSED

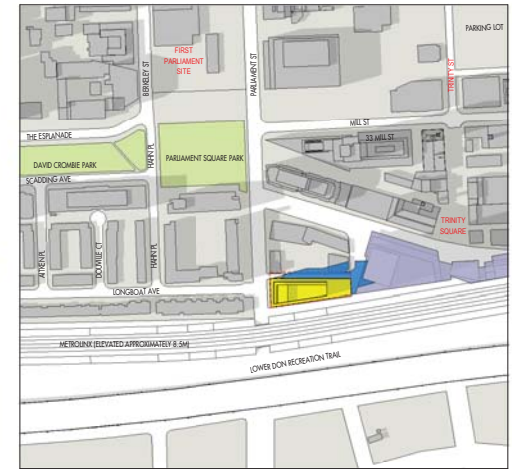

SEPTEMBER 21, 4:18PM

PROPOSED

LEGEND

EXISTING SHADOWS

PROJECT SITE

EXISTING PARKLAND

NET SHADOW IMPACT

PROPOSED DEVELOPMENTS

PREPARED FOR:
1150782 ONTARIO INC.
NOTE: WITHOUT PREJUDICE AND FOR SETTLEMENT PURPOSES ONLY

PROJECT:
**31 PARLIAMENT STREET
TORONTO, CANADA
37 STOREY OPTION**

DRAWING:
SHADOW STUDY - SEPTEMBER

PROJECT NORTH
TRUE NORTH

0 20 50 100 200 METERS
SCALE 1:5000
DATE: 4/12/2018 9:46:01 AM

ARQUITECTONICA

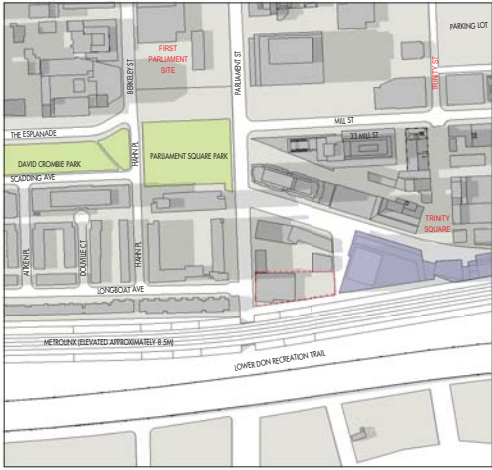

SEPTEMBER 21, 5:18PM

EXISTING

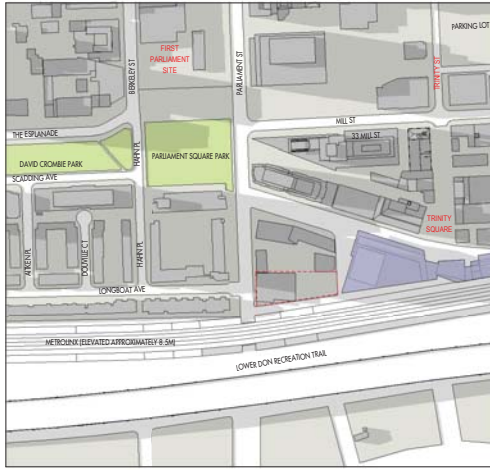

SEPTEMBER 21, 6:18PM

EXISTING

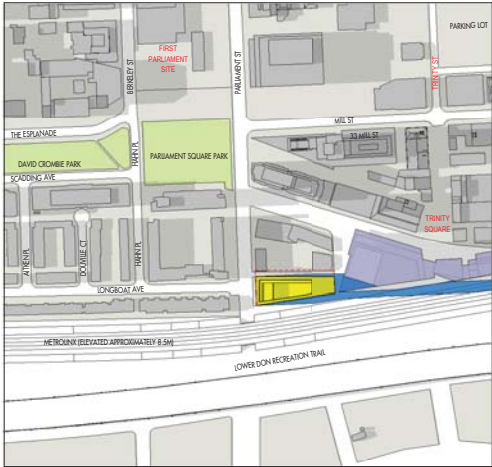

SEPTEMBER 21, 5:18PM

PROPOSED

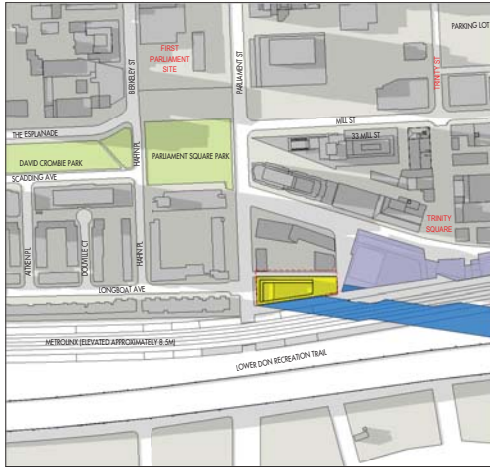

SEPTEMBER 21, 6:18PM

PROPOSED

LEGEND

EXISTING SHADOWS

PROJECT SITE

EXISTING PARKLAND

NET SHADOW IMPACT

PROPOSED DEVELOPMENTS

PREPARED FOR:
1150782 ONTARIO INC.
NOTE: WITHOUT PREJUDICE AND FOR SETTLEMENT PURPOSES ONLY

PROJECT:
**31 PARLIAMENT STREET
TORONTO, CANADA
37 STOREY OPTION**

DRAWING:
SHADOW STUDY - SEPTEMBER

PROJECT NORTH
TRUE NORTH

0 5 10 20 50 METERS
SCALE 1:1500
DATE: 4/12/2018 9:46:09 AM

ARQUITECTONICA

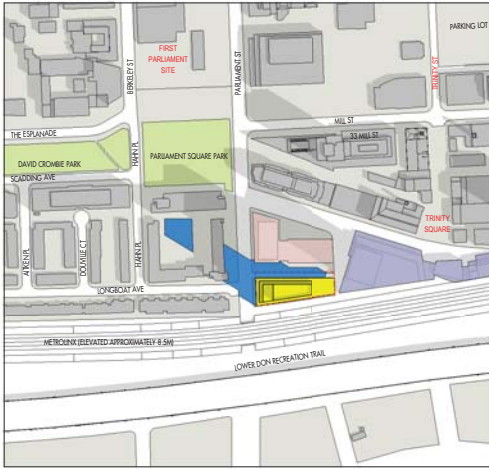

JUNE 21, 10:18AM

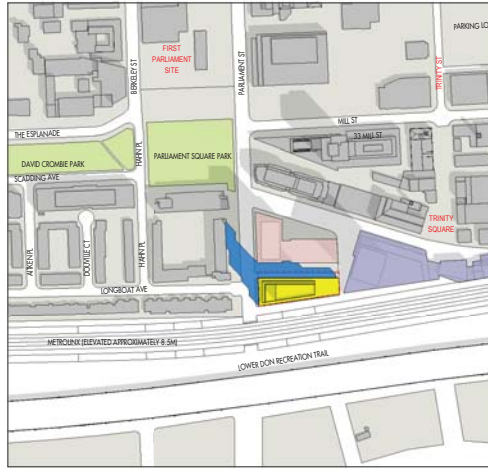

JUNE 21, 11:18AM

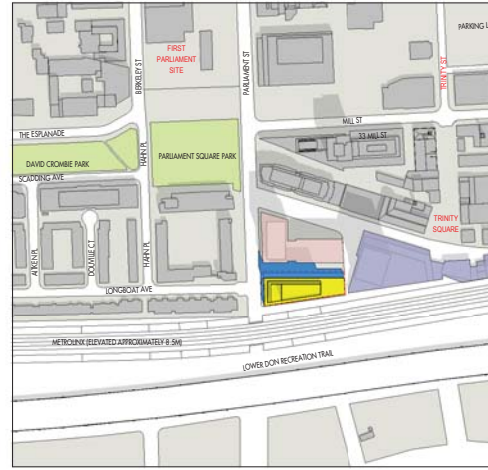

JUNE 21, 12:18PM

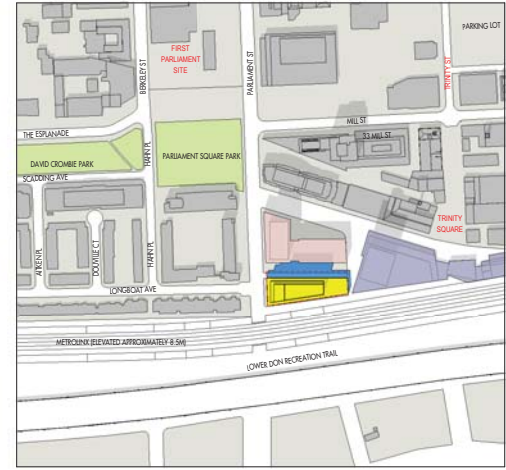

JUNE 21, 1:18PM

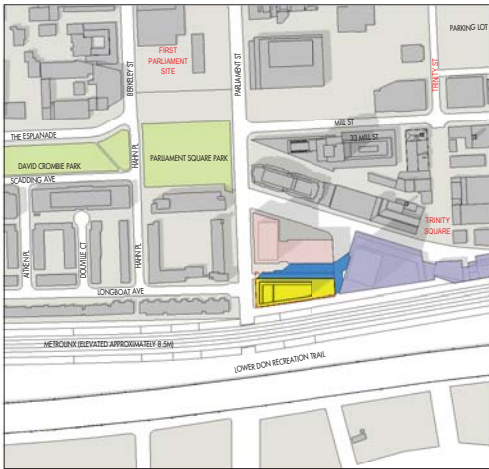

JUNE 21, 2:18PM

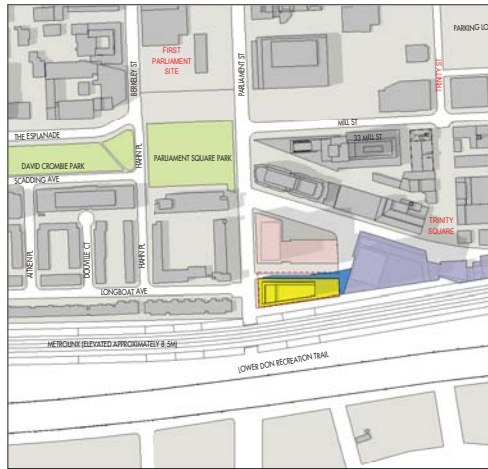

JUNE 21, 3:18PM

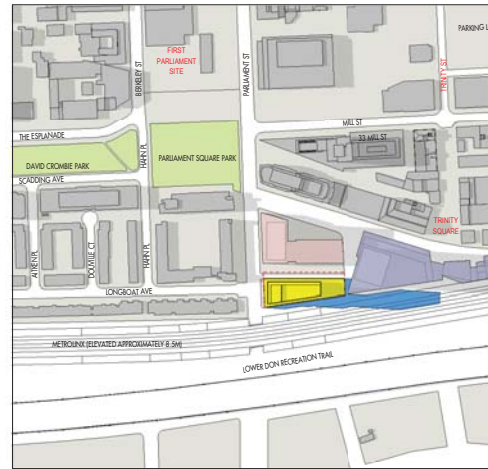

JUNE 21, 4:18PM

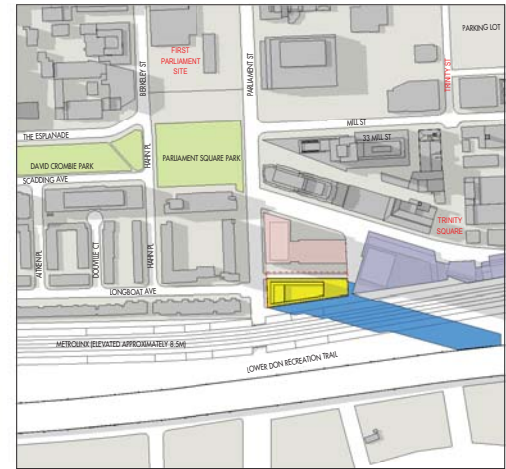

JUNE 21, 5:18PM

LEGEND

- PROJECT SITE
- 33-37 PARLIAMENT AS PROPOSED
- NET GROUND SHADOW IMPACT
- EXISTING SHADOWS
- EXISTING PARKLAND
- 31R PARLIAMENT AS APPROVED

PREPARED FOR:
1150782 ONTARIO INC.
 NOTE: WITHOUT PREJUDICE AND FOR SETTLEMENT PURPOSES ONLY

PROJECT:
**31 PARLIAMENT STREET
 TORONTO, CANADA
 37 STOREY OPTION**

DRAWING:
NET GROUND SHADOW STUDY - PROJECT AS PROPOSED - JUNE

PROJECT NORTH
 TRUE NORTH

ARQUITECTONICA

0 20 50 100 200 METERS
 SCALE 1:5000
 DATE: 4/12/2018 9:46:25 AM

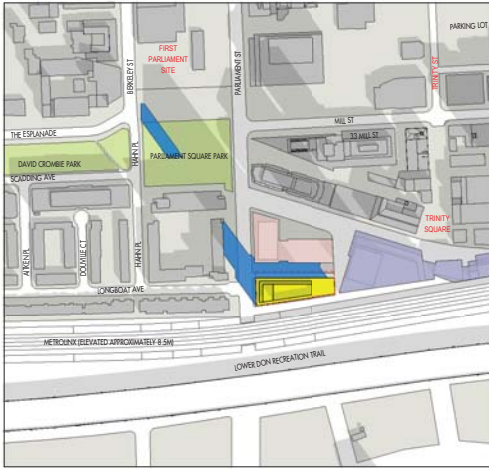

SEPTEMBER 21, 10:18AM

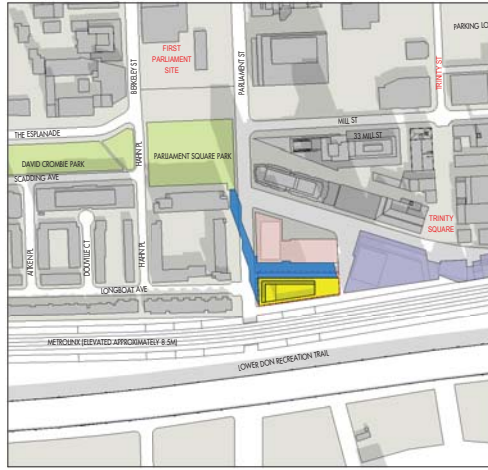

SEPTEMBER 21, 11:18AM

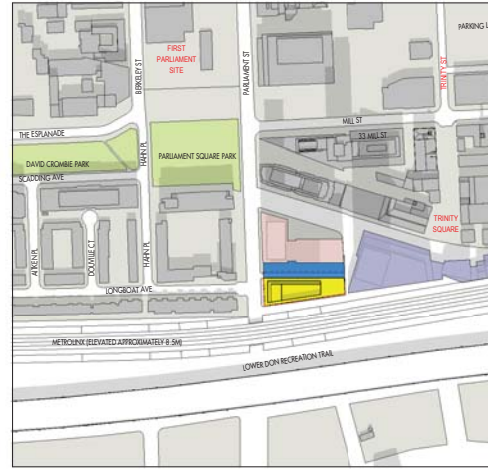

SEPTEMBER 21, 12:18PM

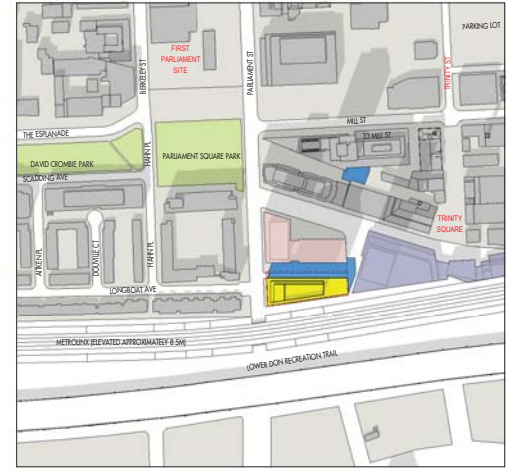

SEPTEMBER 21, 1:18PM

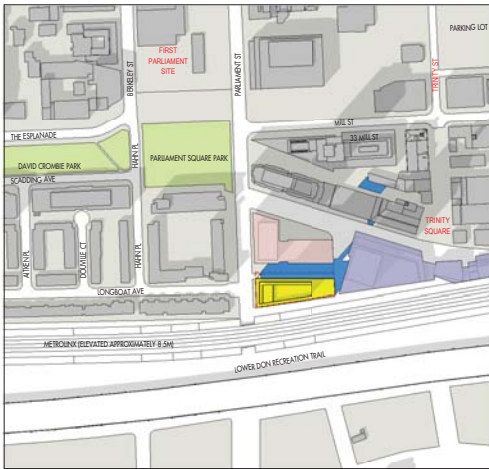

SEPTEMBER 21, 2:18PM

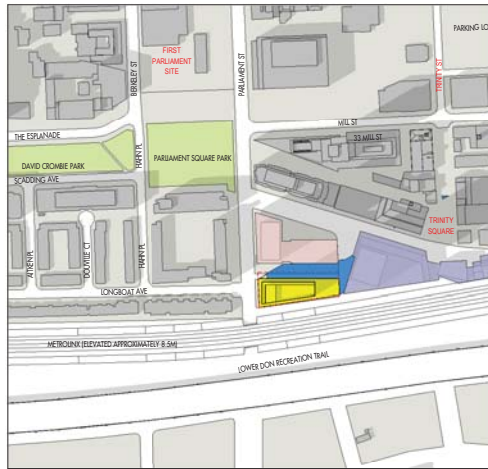

SEPTEMBER 21, 3:18PM

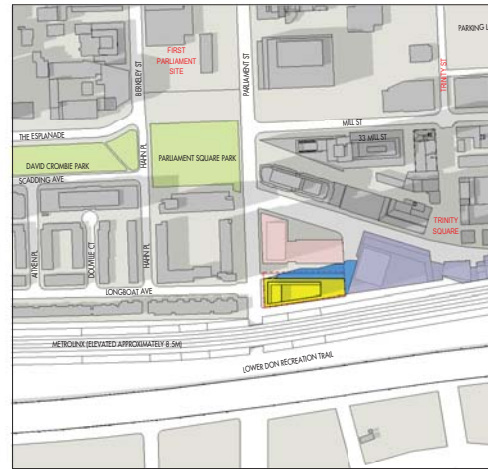

SEPTEMBER 21, 4:18PM

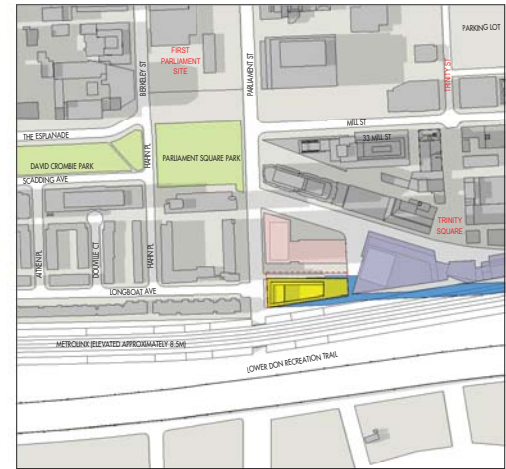

SEPTEMBER 21, 5:18PM

LEGEND

- PROJECT SITE
- 33-37 PARLIAMENT AS PROPOSED
- NET GROUND SHADOW IMPACT
- EXISTING SHADOWS
- EXISTING PARKLAND
- 31R PARLIAMENT AS APPROVED

PREPARED FOR:
1150782 ONTARIO INC.
 NOTE: WITHOUT PREJUDICE AND FOR SETTLEMENT PURPOSES ONLY

PROJECT:
**31 PARLIAMENT STREET
 TORONTO, CANADA
 37 STOREY OPTION**

DRAWING:
NET AT GROUND SHADOW STUDY - PROJECT AS PROPOSED - SEPTEMBER

PROJECT NORTH
 TRUE NORTH

0 20 50 100 200 METERS
 SCALE 1:5000
 DATE: 4/12/2018 9:46:39 AM

ARQUITECTONICA

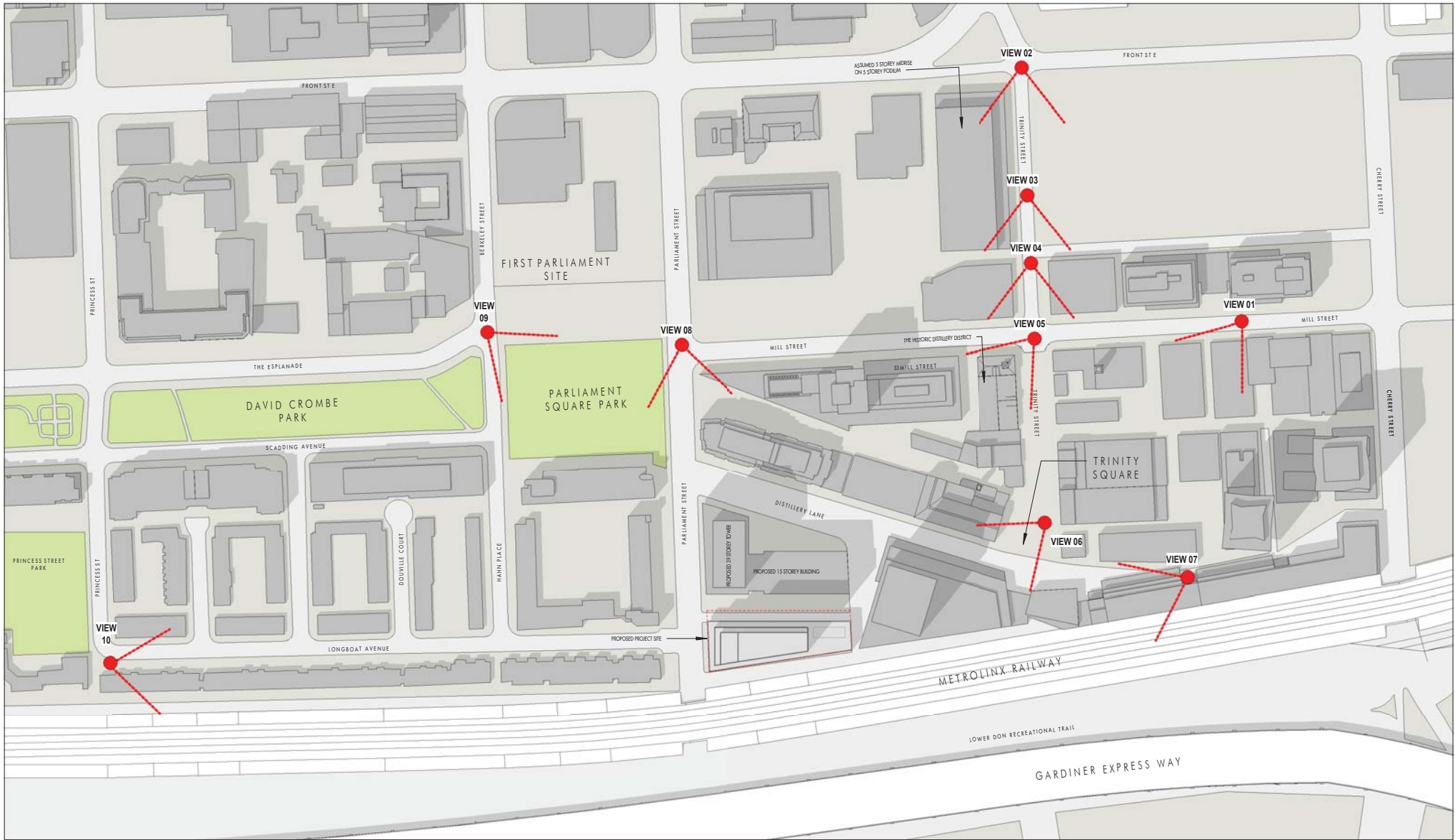

PREPARED FOR:
1150782 ONTARIO INC.

NOTE: WITHOUT PREJUDICE AND FOR
 SETTLEMENT PURPOSES ONLY

PROJECT:
**31 PARLIAMENT STREET
 TORONTO, CANADA
 37 STOREY OPTION**

DRAWING:
VIEW STUDY- KEY PLAN



0 5 10 20 50 100 METERS

SCALE: 1:2000

DATE: 4/12/2018 9:46:45 AM

ARQUITECTONICA



SCALE 1:2000

PREPARED FOR:
1150782 ONTARIO INC.
 NOTE: WITHOUT PREJUDICE AND FOR SETTLEMENT PURPOSES ONLY

PROJECT:
**31 PARLIAMENT STREET
 TORONTO, CANADA
 37 STOREY OPTION**

DRAWING:
VIEW STUDY - VIEW 1



VIEW 1 EXISTING PHOTOGRAPH - N.T.S.

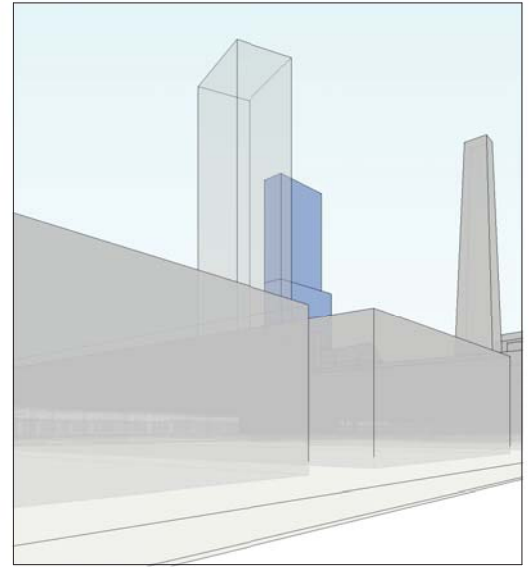

VIEW 1 WITH EXISTING 33-37 PARLIAMENT - N.T.S.

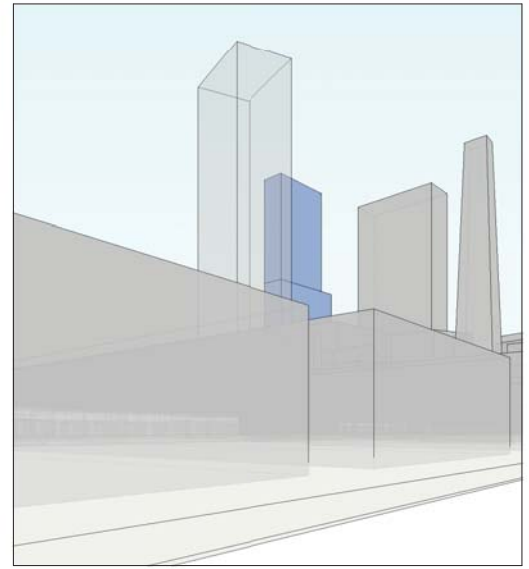

VIEW 1 WITH PROPOSED 33-37 PARLIAMENT - N.T.S.

ARQUITECTONICA

PROJECT NORTH TRUE NORTH
 SCALE 1:2000
 DATE: 4/12/2018 9:46:51 AM

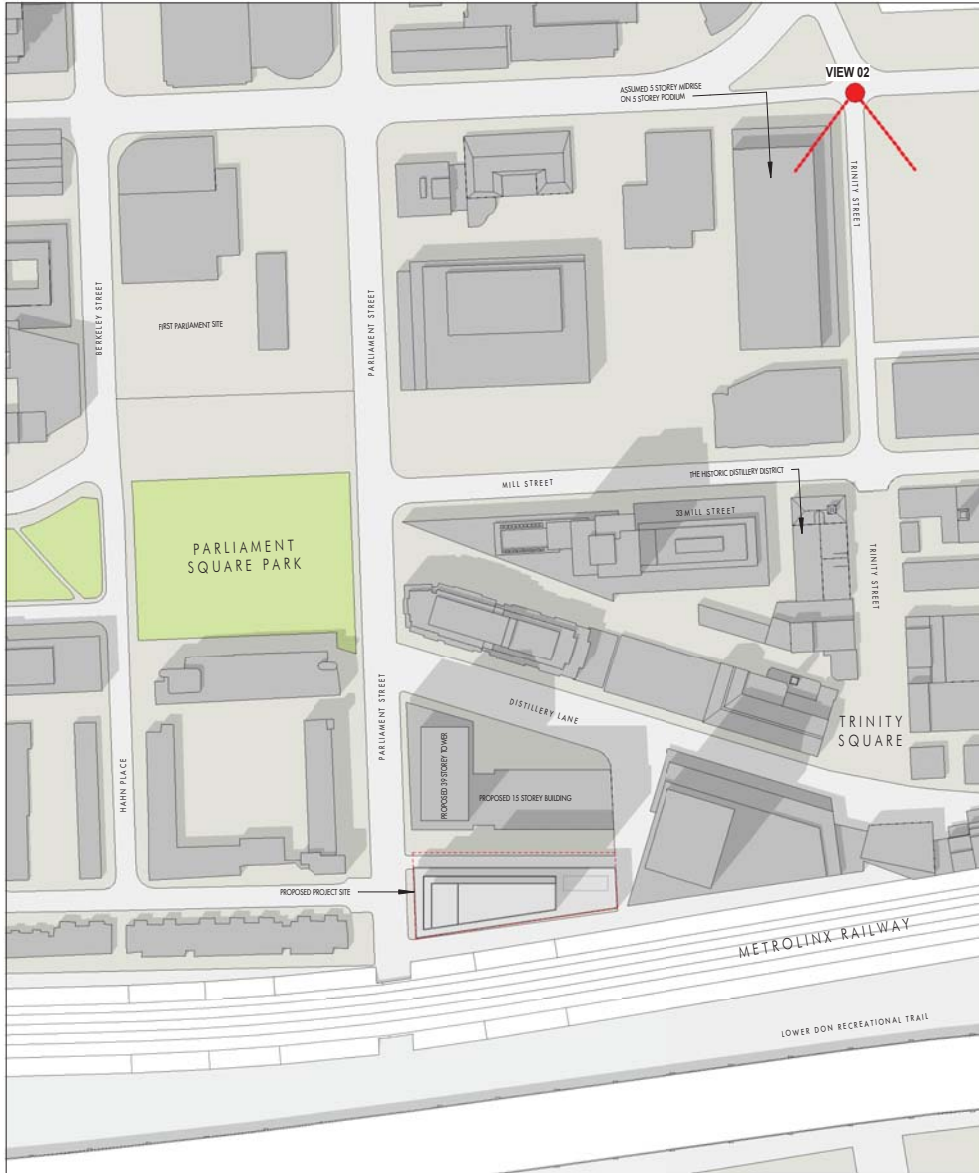

SCALE 1:2000

PREPARED FOR:
1150782 ONTARIO INC.
 NOTE: WITHOUT PREJUDICE AND FOR SETTLEMENT PURPOSES ONLY

PROJECT:
**31 PARLIAMENT STREET
 TORONTO, CANADA
 37 STOREY OPTION**

DRAWING:
VIEW STUDY - VIEW 2

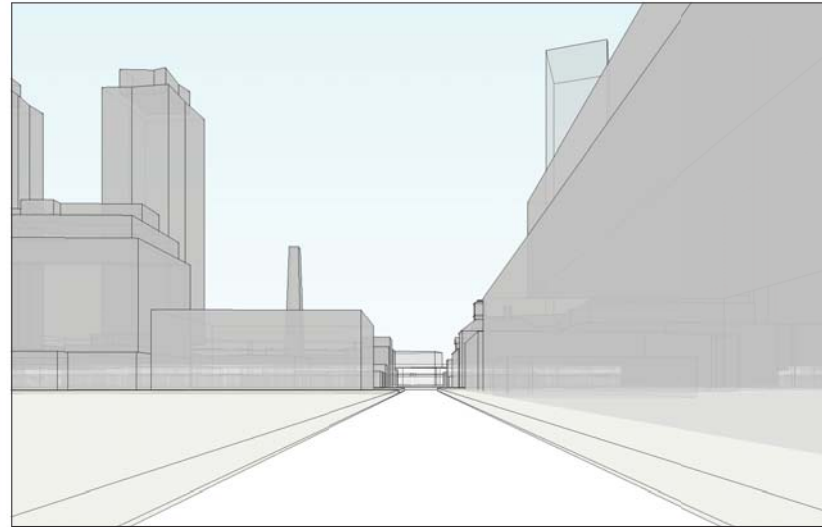

VIEW 2 PROJECT AS PROPOSED - N.T.S.



VIEW 2 EXISTING PHOTOGRAPH - N.T.S.

ARQUITECTONICA

PROJECT NORTH
 TRUE NORTH

0 5 10 20 50 100 METERS
 SCALE 1:2000
 DATE: 4/12/2018 9:46:56 AM

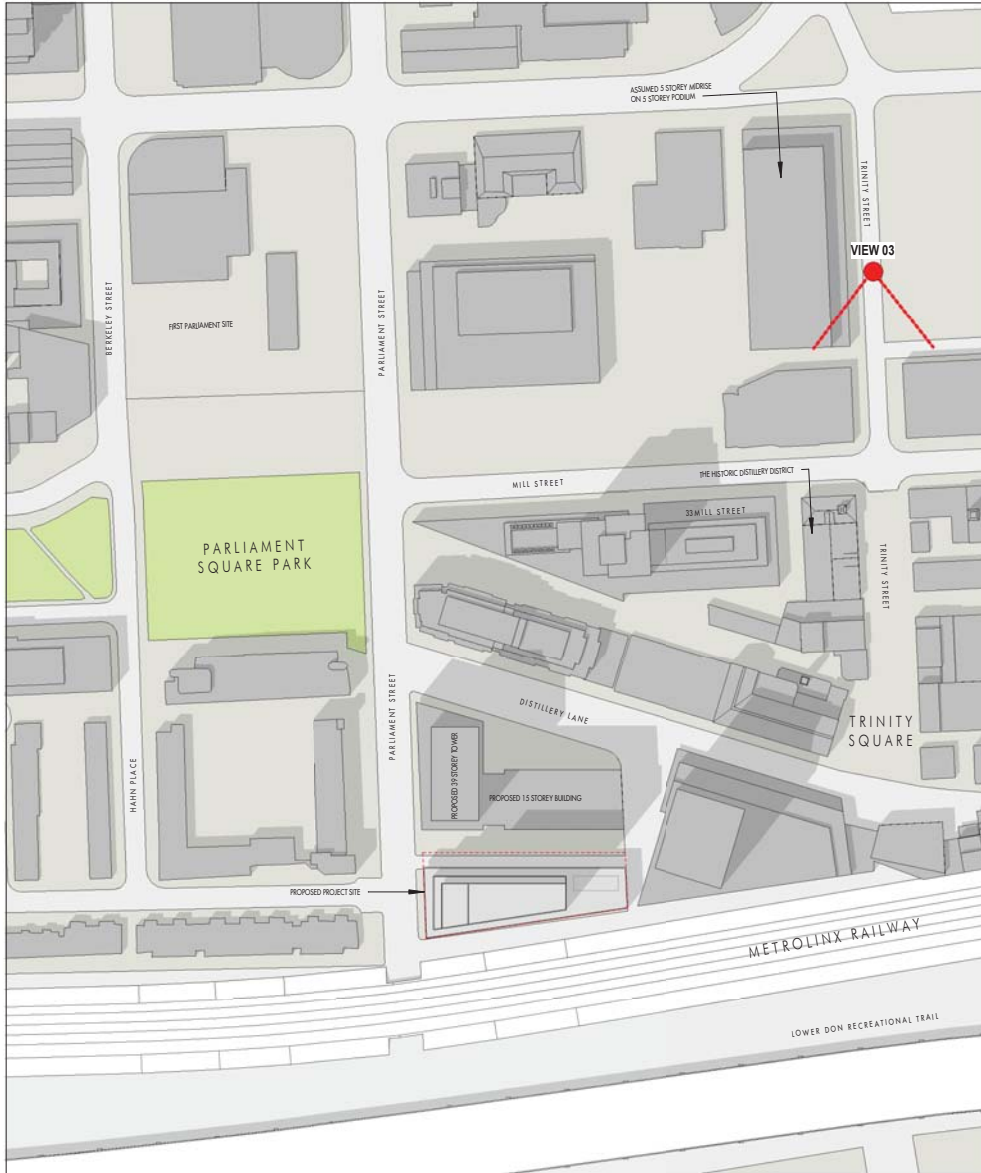

SCALE 1:2000

PREPARED FOR:
1150782 ONTARIO INC.
 NOTE: WITHOUT PREJUDICE AND FOR SETTLEMENT PURPOSES ONLY

PROJECT:
**31 PARLIAMENT STREET
 TORONTO, CANADA
 37 STOREY OPTION**

DRAWING:
VIEW STUDY - VIEW 3

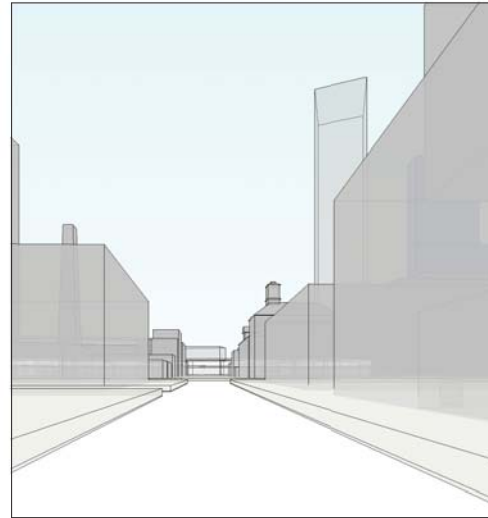

VIEW 3 PROJECT AS PROPOSED - N.T.S.

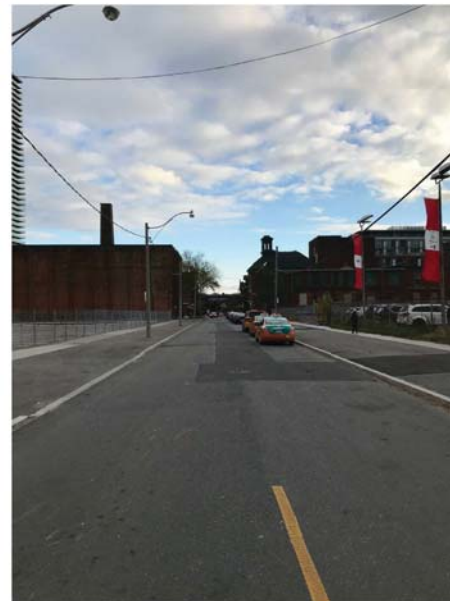

VIEW 3 EXISTING PHOTOGRAPH - N.T.S.

ARQUITECTONICA

PROJECT NORTH
 TRUE NORTH

0 5 10 20 50 100 METERS
 SCALE 1:2000
 DATE: 4/12/2018 9:47:01 AM

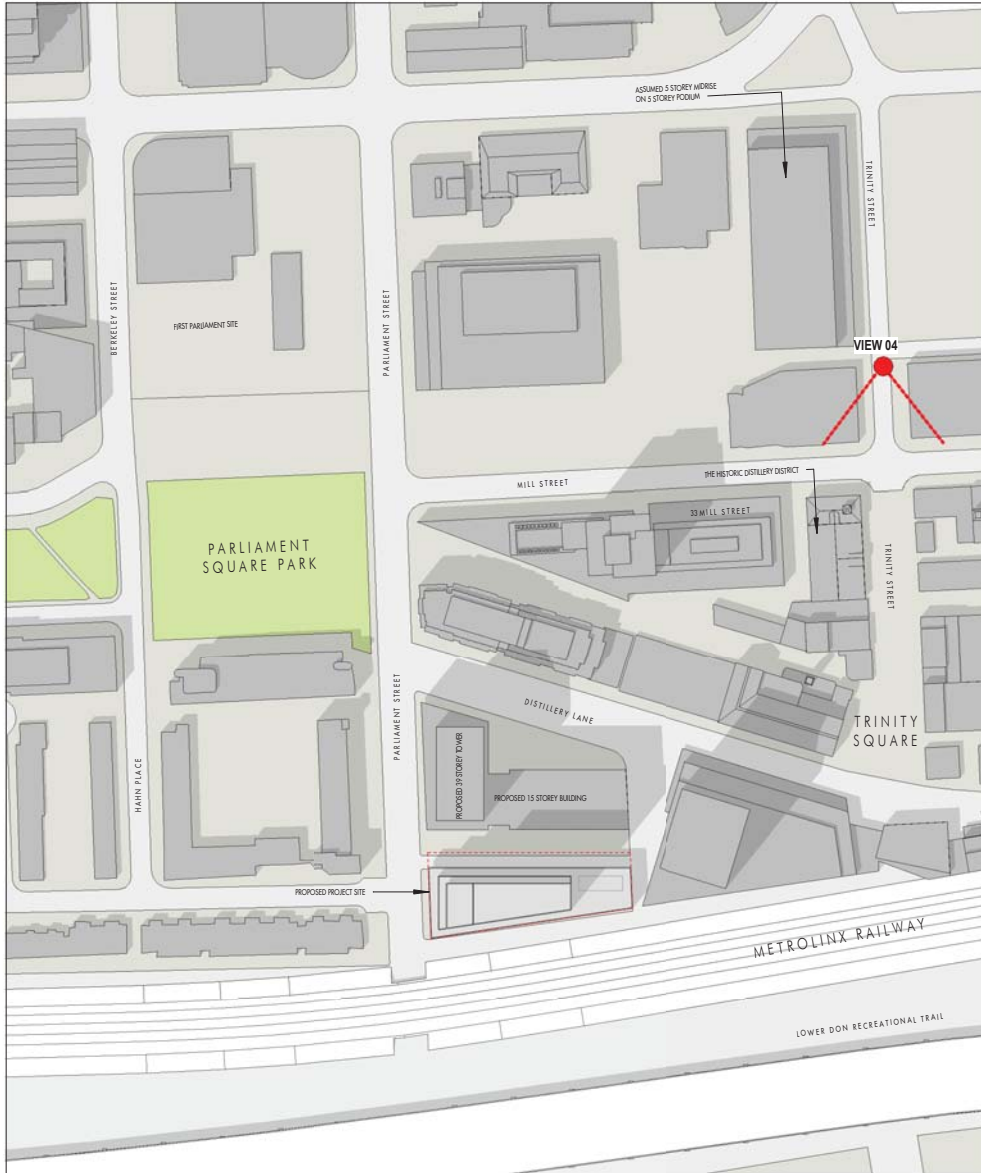

SCALE 1:2000

PREPARED FOR:
1150782 ONTARIO INC.
 NOTE: WITHOUT PREJUDICE AND FOR SETTLEMENT PURPOSES ONLY

PROJECT:
**31 PARLIAMENT STREET
 TORONTO, CANADA
 37 STOREY OPTION**

DRAWING:
VIEW STUDY - VIEW 4

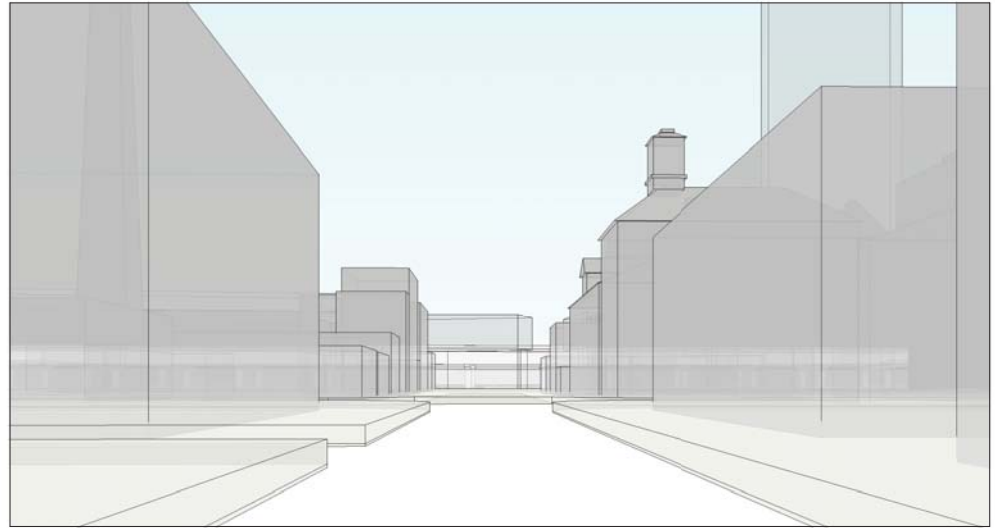

VIEW 4 PROJECT AS PROPOSED - N.T.S.



VIEW 4 EXISTING PHOTOGRAPH - N.T.S.

ARQUITECTONICA

PROJECT NORTH TRUE NORTH SCALE: 2000 DATE: 4/12/2018 9:47:07 AM

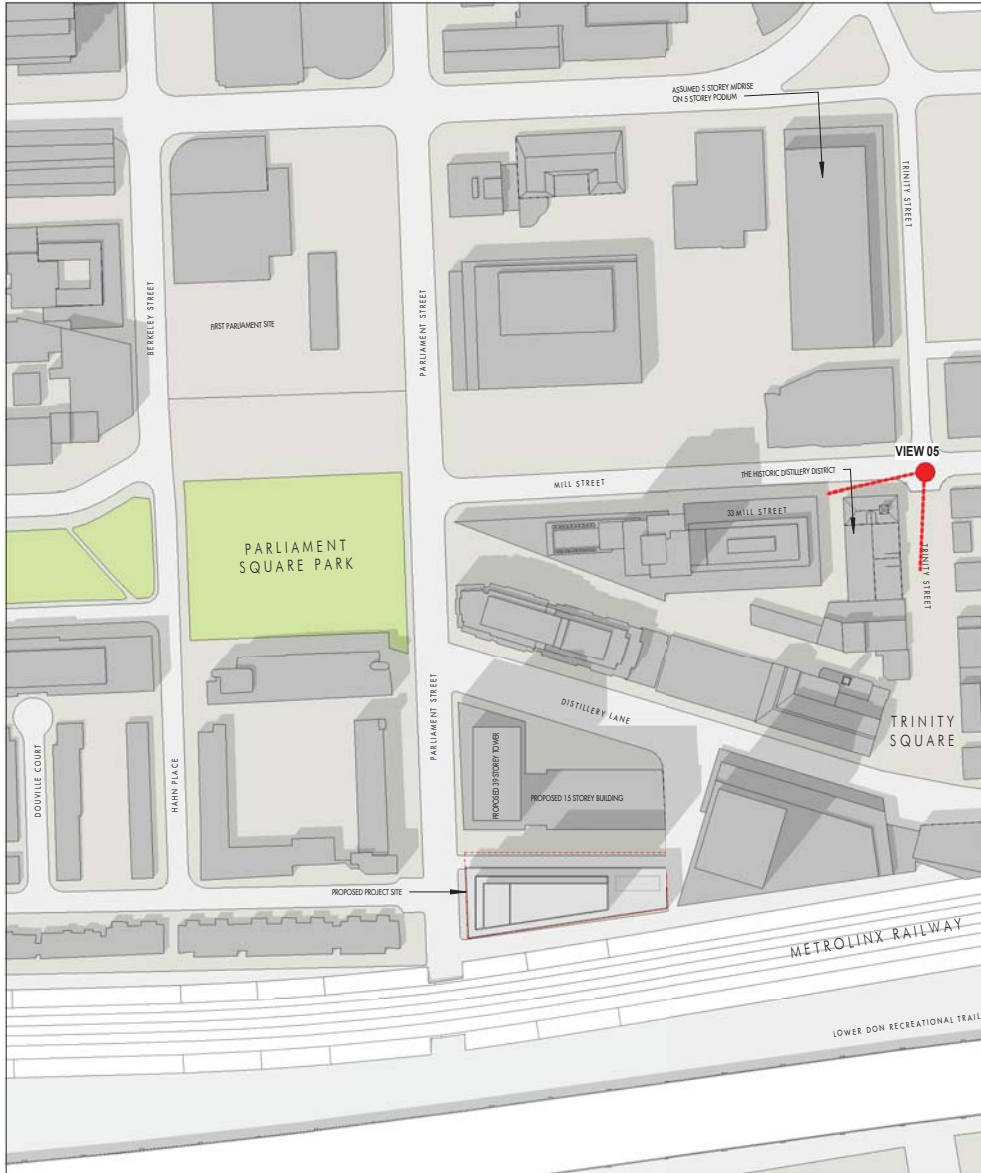

SCALE 1:2000

PREPARED FOR:
1150782 ONTARIO INC.
 NOTE: WITHOUT PREJUDICE AND FOR SETTLEMENT PURPOSES ONLY

PROJECT:
**31 PARLIAMENT STREET
 TORONTO, CANADA
 37 STOREY OPTION**

DRAWING:
VIEW STUDY - VIEW 5



VIEW 5 EXISTING PHOTOGRAPH - N.T.S.

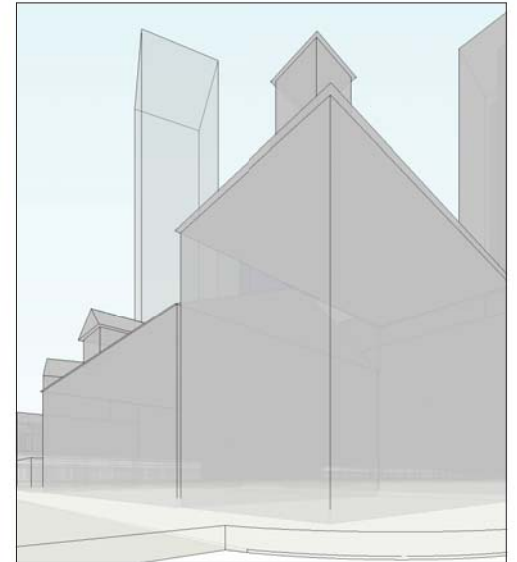

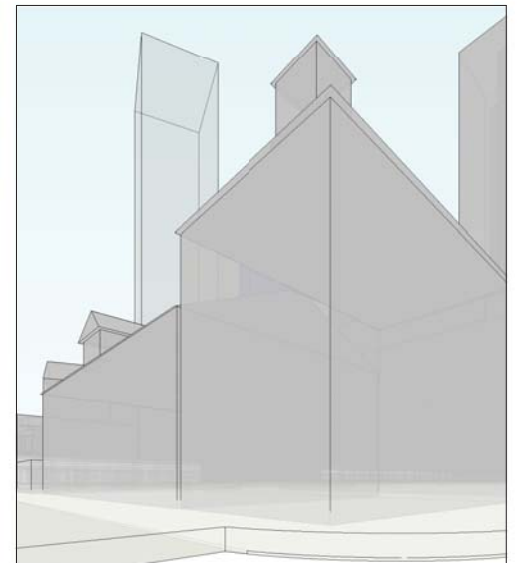

VIEW 5 WITH EXISTING 33-37 PARLIAMENT - N.T.S.



VIEW 5 WITH PROPOSED 33-37 PARLIAMENT - N.T.S.

ARQUITECTONICA

 PROJECT NORTH
 TRUE NORTH
 SCALE 1:2000
 DATE: 4/12/2018 9:47:13 AM

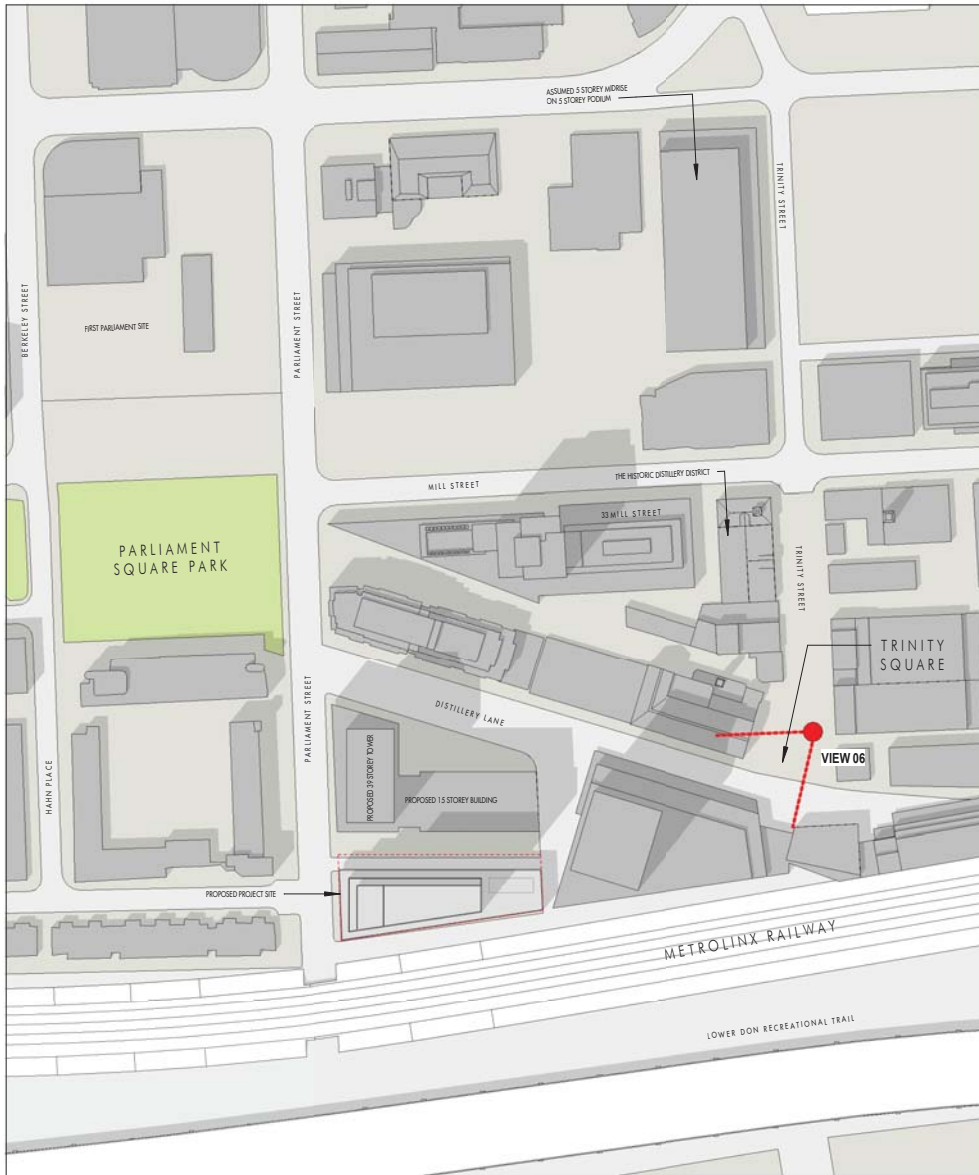

SCALE 1:2000

PREPARED FOR:
1150782 ONTARIO INC.
 NOTE: WITHOUT PREJUDICE AND FOR SETTLEMENT PURPOSES ONLY

PROJECT:
31 PARLIAMENT STREET
TORONTO, CANADA
37 STOREY OPTION

DRAWING:
VIEW STUDY - VIEW 6



VIEW 6 EXISTING PHOTOGRAPH - N.T.S.

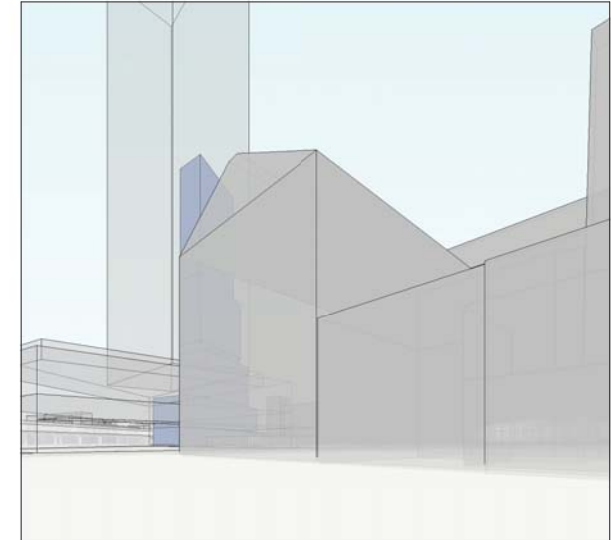

VIEW 6 WITH EXISTING 33-37 PARLIAMENT - N.T.S.

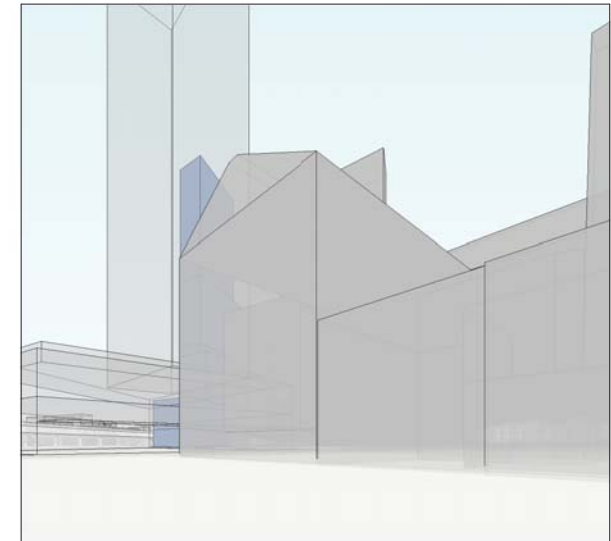

VIEW 6 WITH PROPOSED 33-37 PARLIAMENT - N.T.S.

ARQUITECTONICA

PROJECT NORTH
 TRUE NORTH

0 5 10 20 50 100 METERS
 SCALE 1:2000
 DATE: 4/12/2018 9:47:19 AM



SCALE 1:2000

PREPARED FOR:
1150782 ONTARIO INC.
 NOTE: WITHOUT PREJUDICE AND FOR SETTLEMENT PURPOSES ONLY

PROJECT:
**31 PARLIAMENT STREET
 TORONTO, CANADA
 37 STOREY OPTION**

DRAWING:
VIEW STUDY - VIEW 7



VIEW 7 EXISTING PHOTOGRAPH - N.T.S.

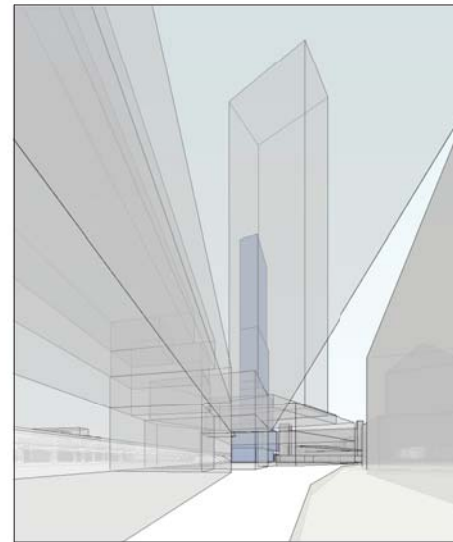

VIEW 7 WITH EXISTING 33-37 PARLIAMENT - N.T.S.

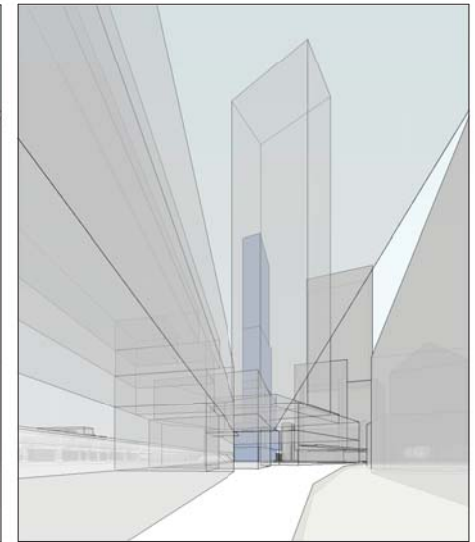

VIEW 7 WITH PROPOSED 33-37 PARLIAMENT - N.T.S.

ARQUITECTONICA

PROJECT NORTH
 TRUE NORTH

0 5 10 20 50 100 METERS
 SCALE 1:2000
 DATE: 4/12/2018 9:47:26 AM

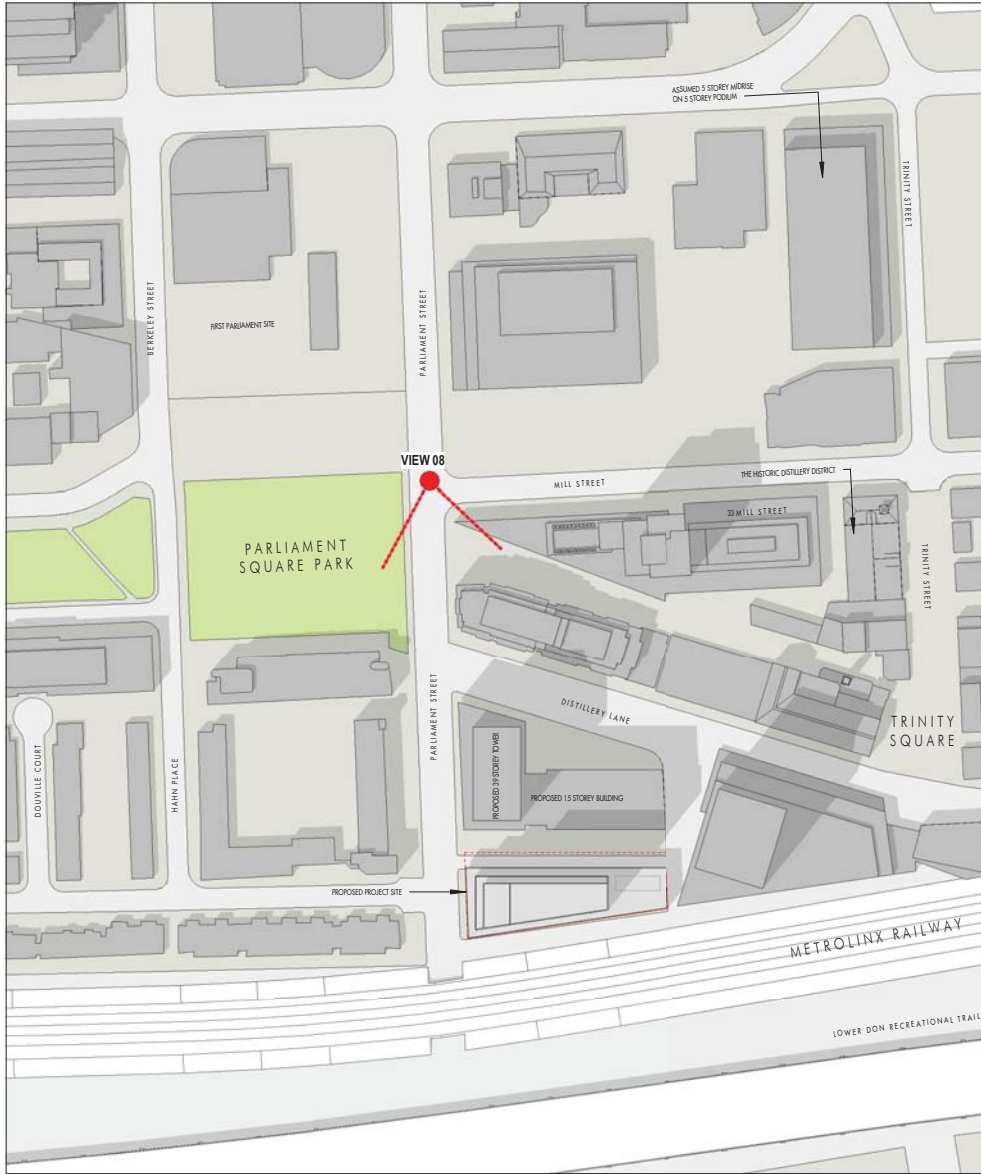

SCALE 1:2000

PREPARED FOR:
1150782 ONTARIO INC.
 NOTE: WITHOUT PREJUDICE AND FOR SETTLEMENT PURPOSES ONLY

PROJECT:
**31 PARLIAMENT STREET
 TORONTO, CANADA
 37 STOREY OPTION**

DRAWING:
VIEW STUDY - VIEW 8



VIEW 8 EXISTING PHOTOGRAPH - N.T.S.

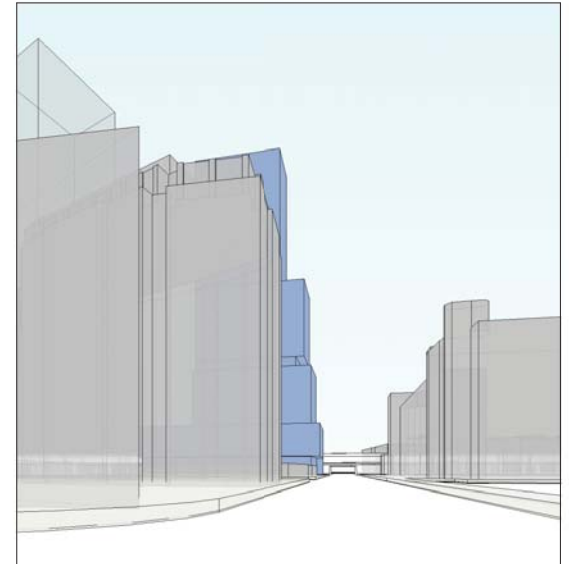

VIEW 8 WITH EXISTING 33-37 PARLIAMENT - N.T.S.

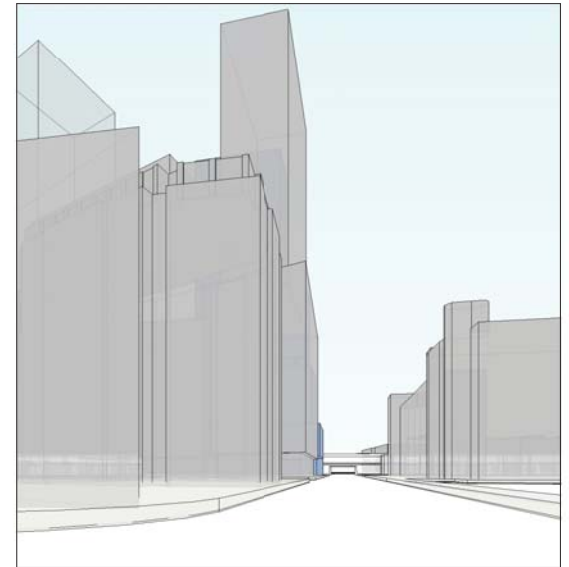

VIEW 8 WITH PROPOSED 33-37 PARLIAMENT - N.T.S.

ARQUITECTONICA

PROJECT NORTH
 TRUE NORTH

0 5 10 20 50 100 METERS
 SCALE 1:2000
 DATE: 4/12/2018 9:47:32 AM

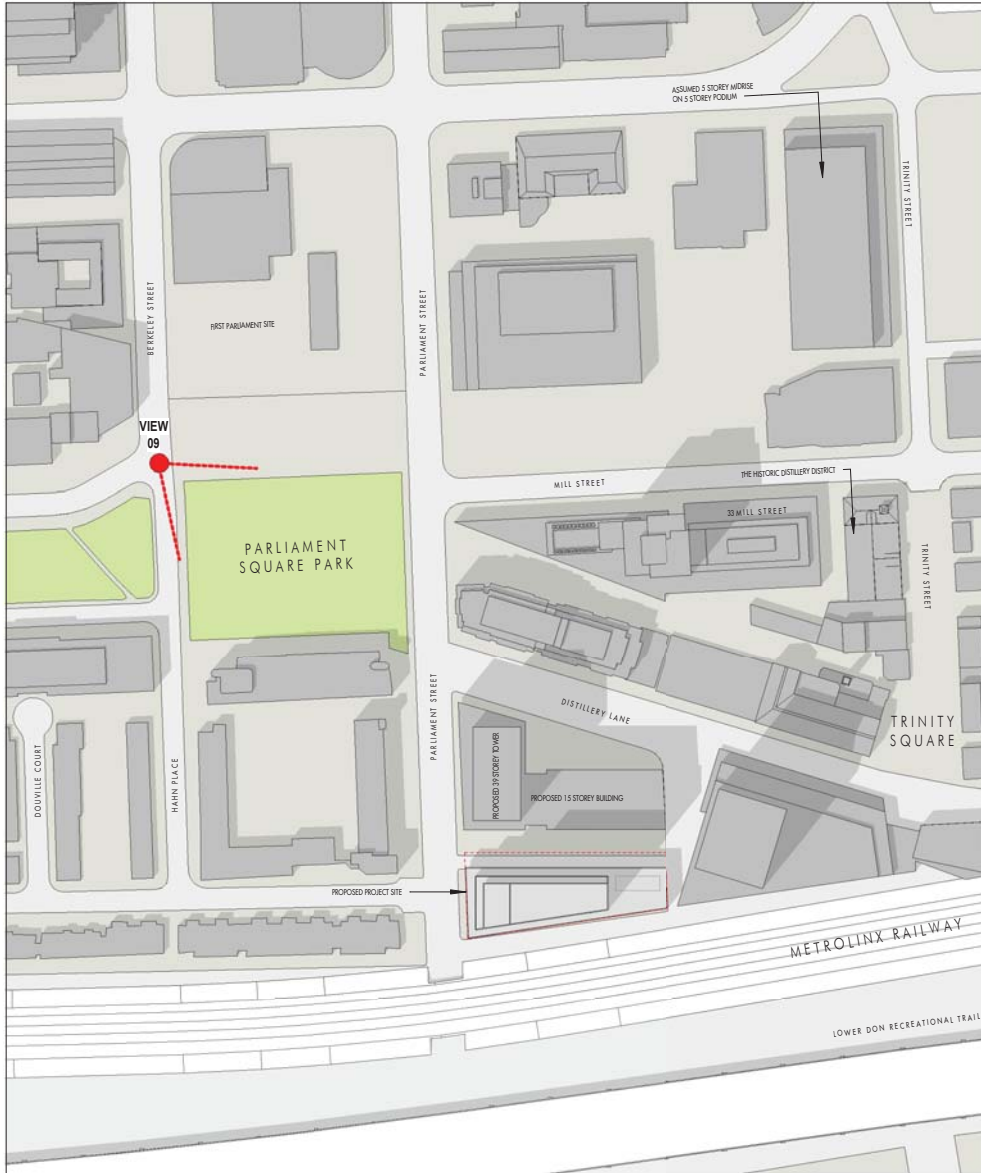

SCALE 1:2000

PREPARED FOR:
1150782 ONTARIO INC.
 NOTE: WITHOUT PREJUDICE AND FOR SETTLEMENT PURPOSES ONLY

PROJECT:
**31 PARLIAMENT STREET
 TORONTO, CANADA
 37 STOREY OPTION**

DRAWING:
VIEW STUDY - VIEW 9



VIEW 9 EXISTING PHOTOGRAPH - N.T.S.

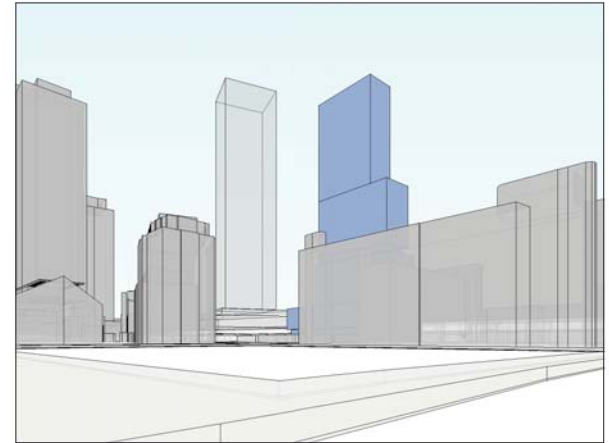

VIEW 9 WITH EXISTING 33-37 PARLIAMENT - N.T.S.

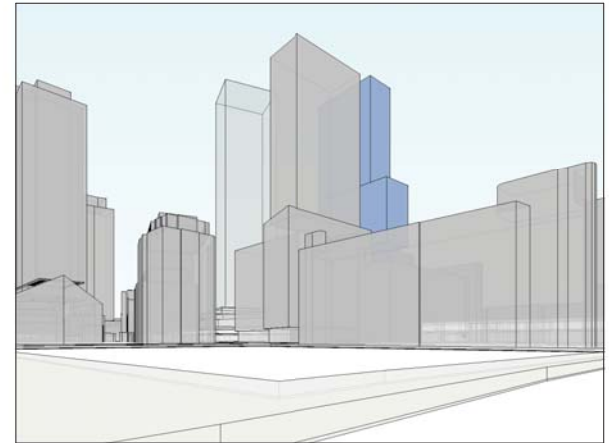

VIEW 9 WITH PROPOSED 33-37 PARLIAMENT - N.T.S.

ARQUITECTONICA

PROJECT NORTH
 TRUE NORTH

0 5 10 20 50 100 METERS
 SCALE 1:2000
 DATE: 4/12/2018 9:47:38 AM

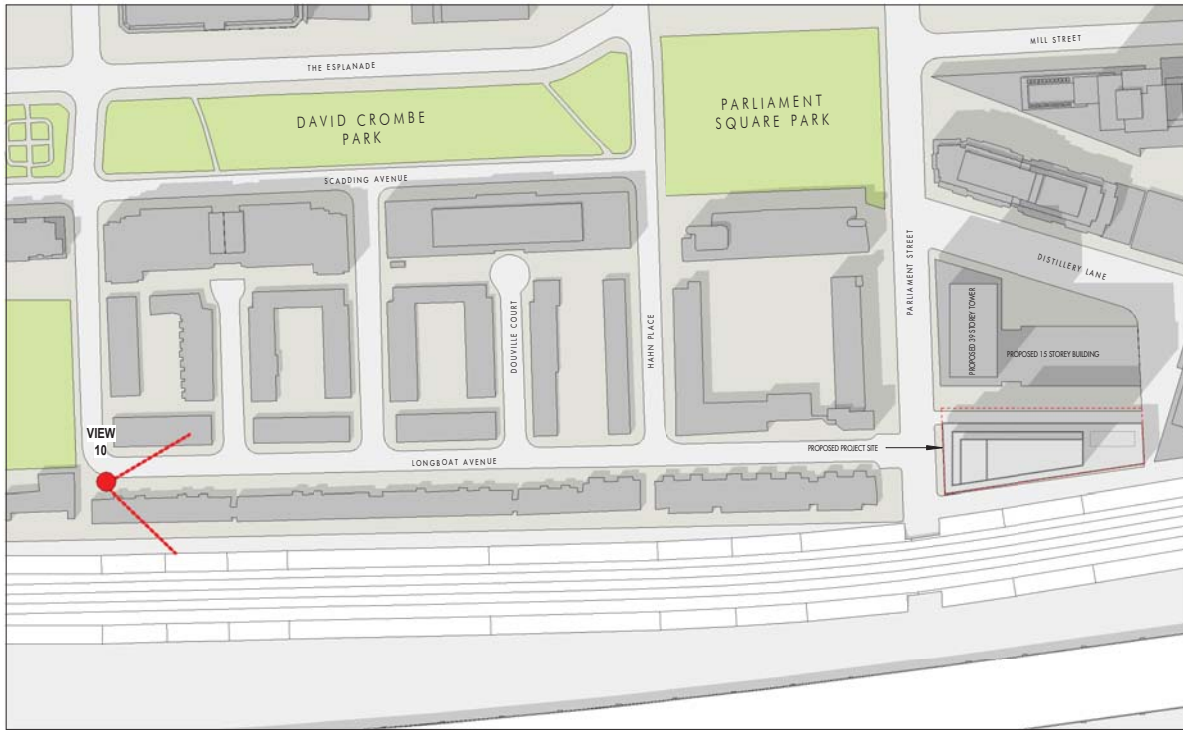

VIEW 10 EXISTING PHOTOGRAPH - N.T.S.

SCALE 1:2000

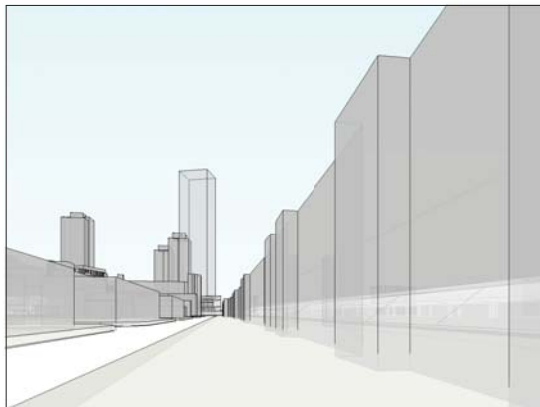

VIEW 10 WITH EXISTING 31 PARLIAMENT AND EXISTING 33-37 PARLIAMENT - N.T.S.

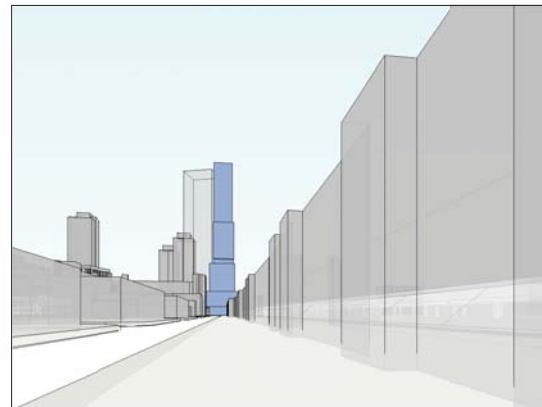

VIEW 10 WITH EXISTING 33-37 PARLIAMENT - N.T.S.

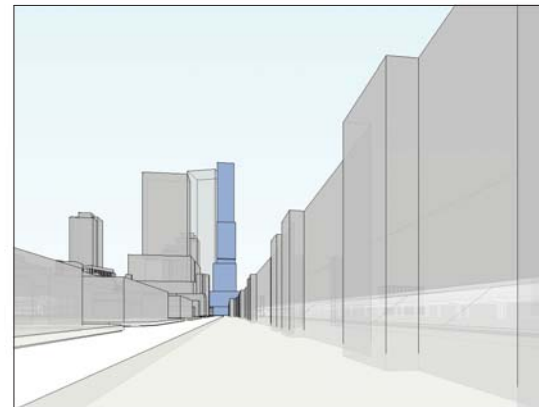

VIEW 10 WITH PROPOSED 33-37 PARLIAMENT - N.T.S.

PREPARED FOR:
1150782 ONTARIO INC.
 NOTE: WITHOUT PREJUDICE AND FOR SETTLEMENT PURPOSES ONLY

PROJECT:
**31 PARLIAMENT STREET
 TORONTO, CANADA
 37 STOREY OPTION**

DRAWING:
VIEW STUDY - VIEW 10

PROJECT NORTH
 TRUE NORTH

0 5 10 20 50 100 METERS
 SCALE 1:2000
 DATE: 4/12/2018 9:47:43 AM

ARQUITECTONICA



ARQUITECTONICA

PREPARED FOR:
1150782 ONTARIO INC.

PROJECT:
**31 PARLIAMENT STREET
TORONTO, CANADA
37 STOREY OPTION**

DRAWING:
VIEW LOOKING SOUTHWEST

PROJECT
NORTH

TRUE
NORTH

DATE: 4/12/2018 9:47:45 AM