

ISSUES	No.	DESCRIPTION	DATE
	01	REZONING 1 SUBMISSION	2019/12/04
	02	REZONING 2 SUBMISSION	2021/10/20
	03	SPA SUBMISSION_BLOCK 1 AND 2	2021/12/24
	04	REZONING 3 SUBMISSION	2022/10/26
	05	REZONING 4 SUBMISSION	2024/02/06

SEAL

PROJECT

670-690  
PROGRESS AVE.

PROJECT NO: 121606

DRAWN BY: DATE: 06 FEB. 2024

SCALE: 1:200 APPROVED BY:

**ARCADIS**  
ARCADIS ARCHITECTS (CANADA) INC.  
55 St. Clair Avenue West  
Suite 700 Toronto, ON  
M5V 2Y7  
Tel: 416-596-1930

SHEET TITLE

**P2 LEVEL PLAN  
(BLOCK 3, 4 & 5)**

SHEET NUMBER **A.124** ISSUE

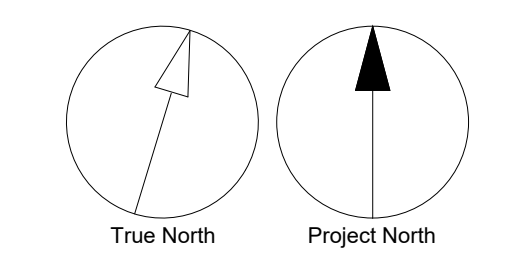
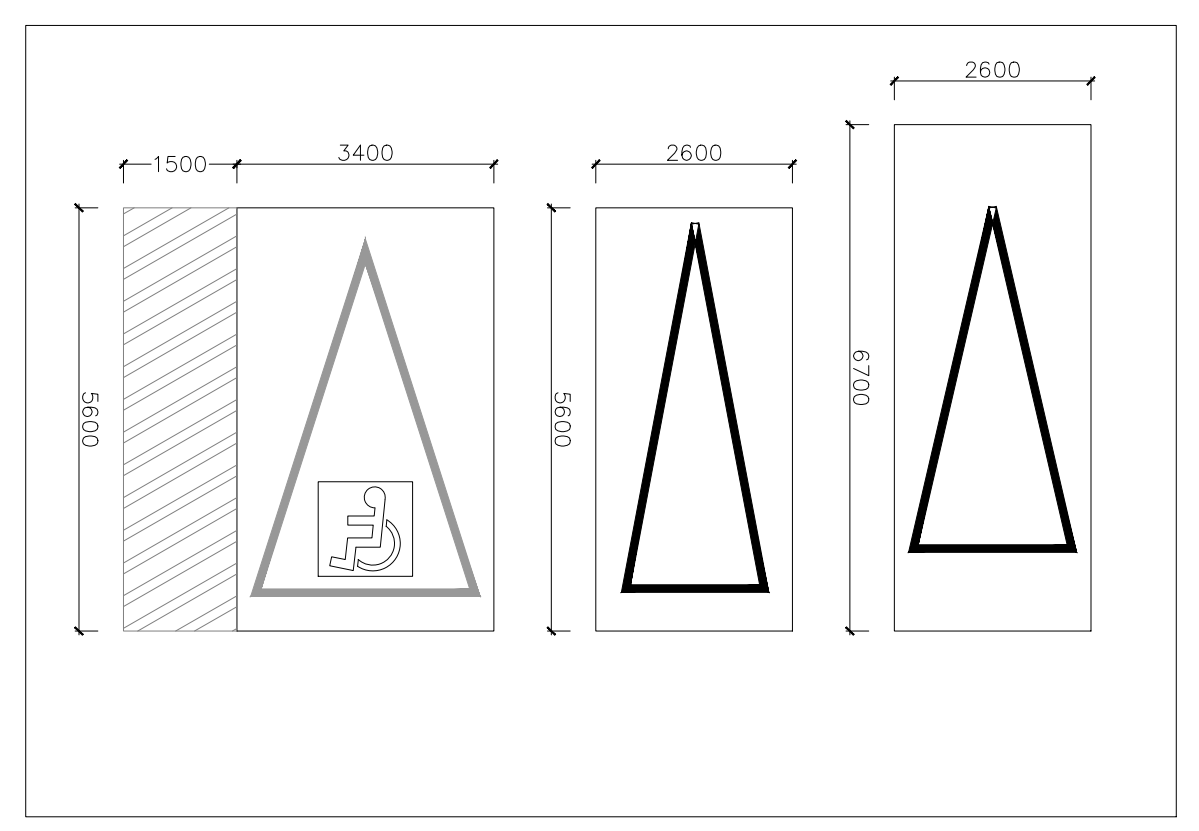

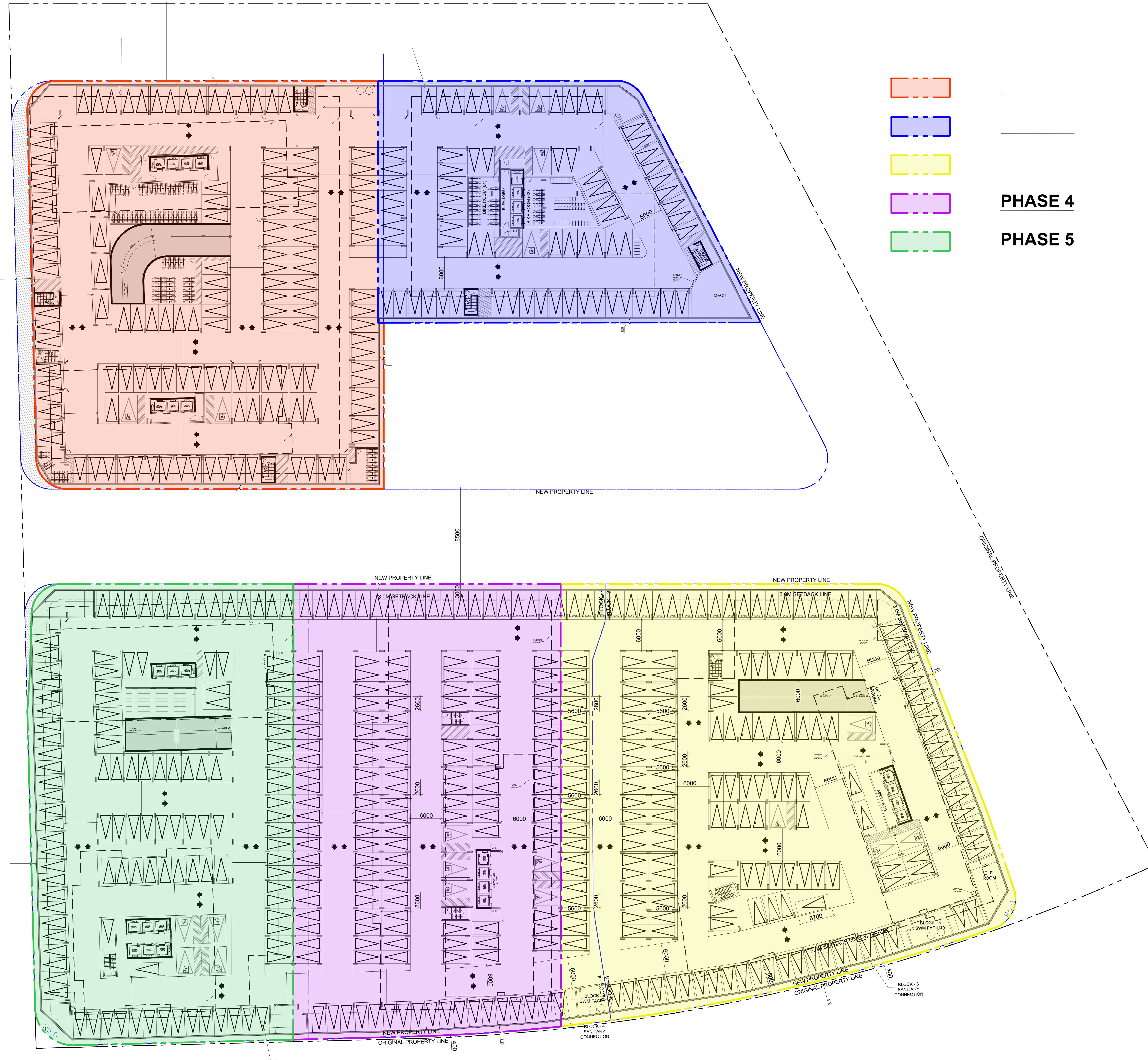

ISSUES		
No.	DESCRIPTION	DATE
01	REZONING 1 SUBMISSION	2019/12/04
02	REZONING 2 SUBMISSION	2021/10/20
03	SPA SUBMISSION_BLOCK 1 AND 2	2021/12/24
04	REZONING 3 SUBMISSION	2022/10/26
05	REZONING 4 SUBMISSION	2024/02/06

SEAL



PROJECT

670-690  
PROGRESS AVE.

PROJECT NO: 121606

DRAWN BY: DATE: 06 FEB. 2024

SCALE: 1:200 APPROVED BY:

**ARCADIS**  
ARCADIS ARCHITECTS (CANADA) INC.  
55 St. Clair Avenue West  
Suite 700 Toronto, ON  
M5V 2Y7  
Tel: 416-596-1930

SHEET TITLE

P2 LEVEL PLAN  
PHASING PLAN

SHEET NUMBER  
A.125

ISSUE

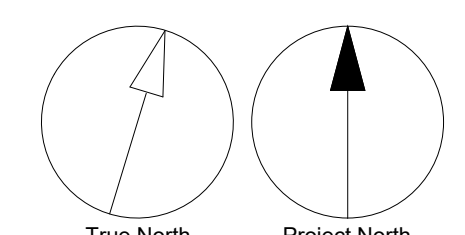
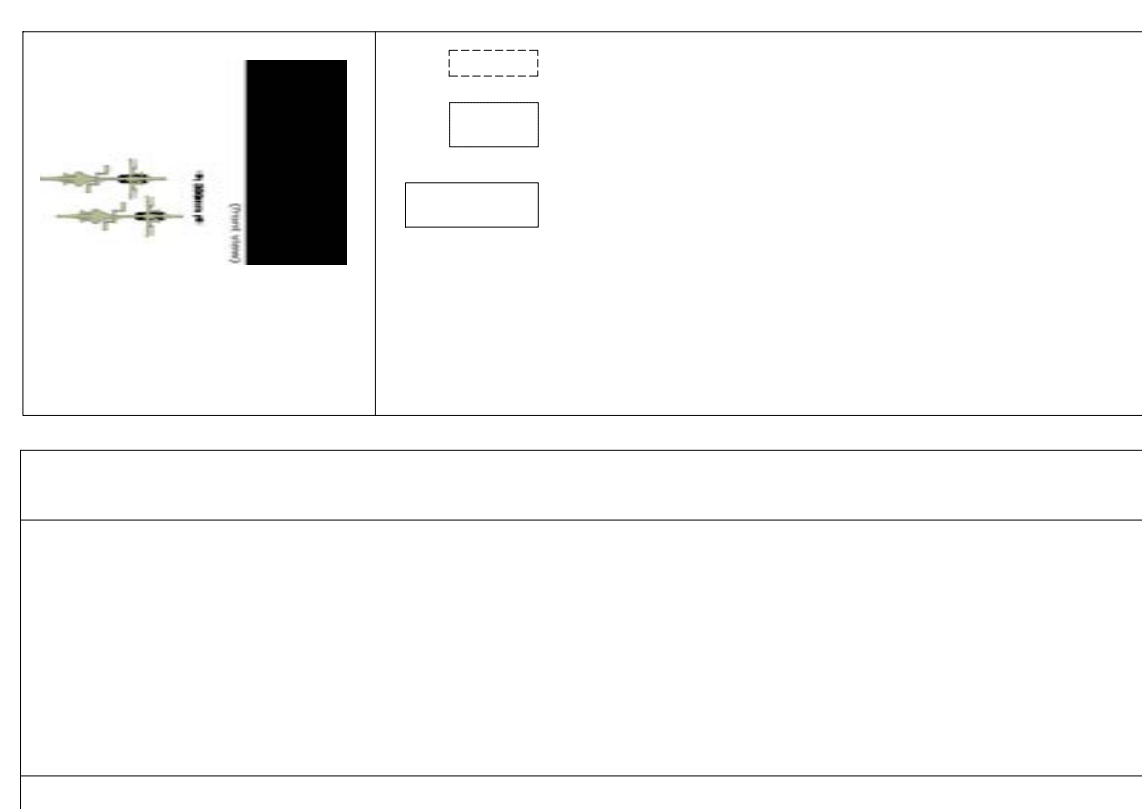
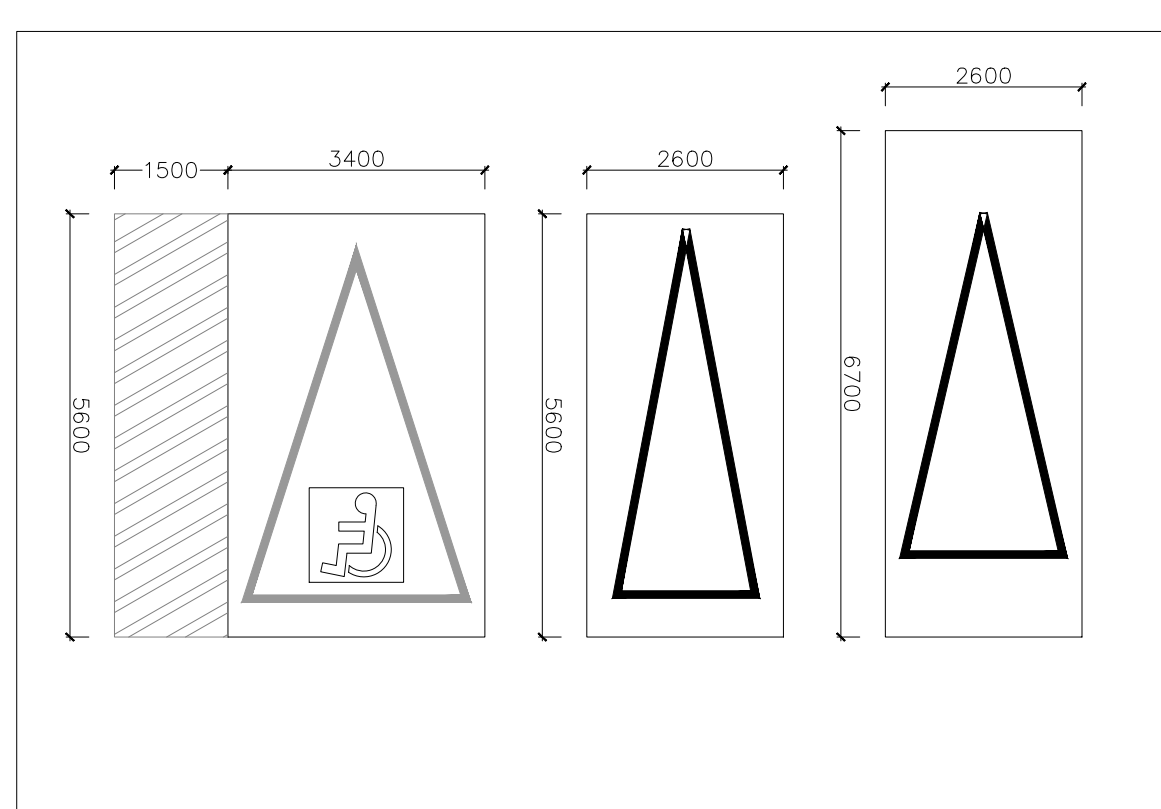

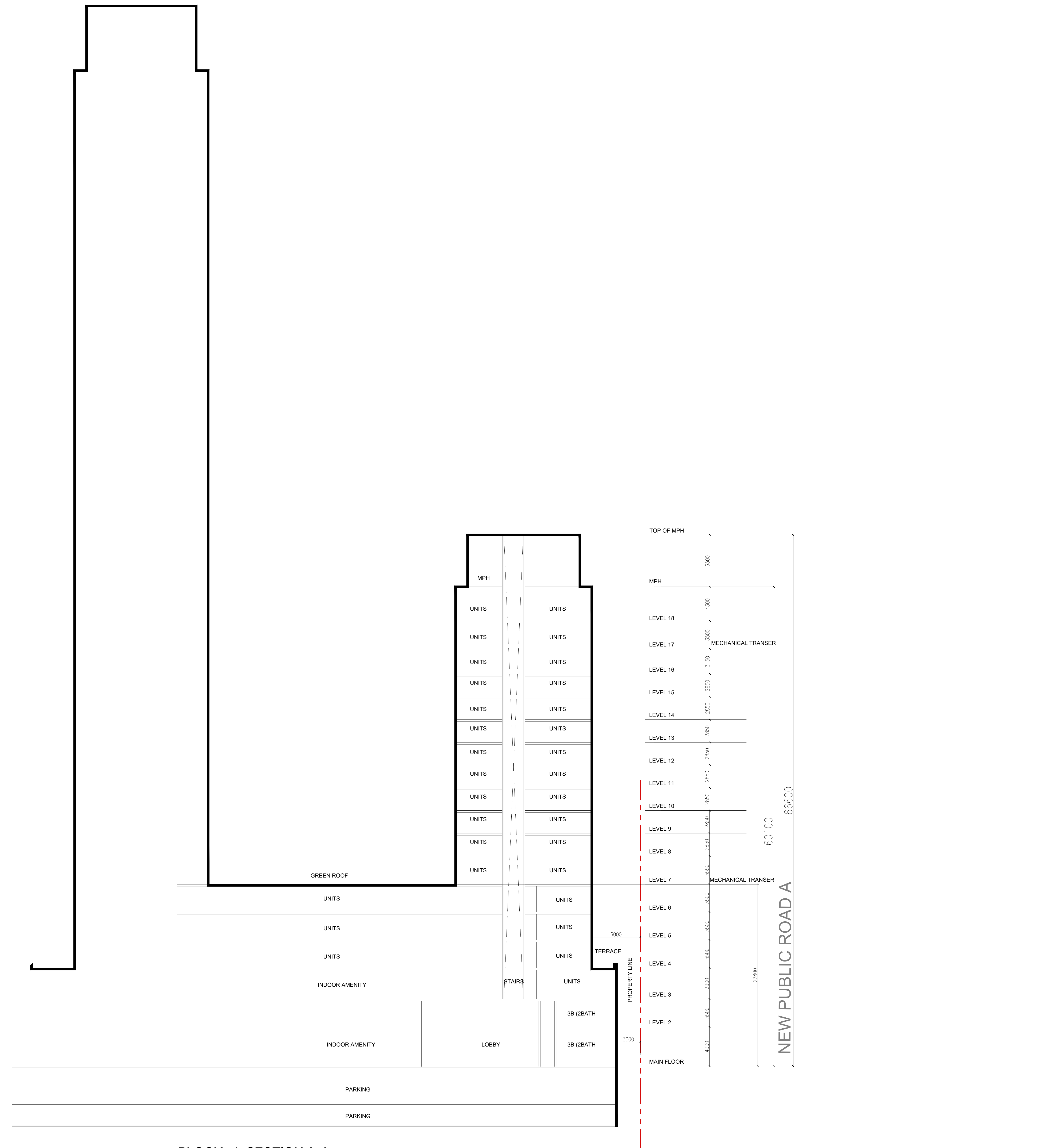

ISSUES		
No.	DESCRIPTION	DATE
01	REZONING 1 SUBMISSION	2019/12/04
02	REZONING 2 SUBMISSION	2021/10/20
03	SPA SUBMISSION_BLOCK 1 AND 2	2021/12/24
04	REZONING 3 SUBMISSION	2022/10/26
05	REZONING 4 SUBMISSION	2024/02/06



PROJECT

**670-690  
PROGRESS AVE.**

PROJECT NO: **121606**

DRAWN BY: DATE: 06 FEB. 2024

SCALE: **1:200** APPROVED BY:

**ARCADIS**  
ARCADIS ARCHITECTS (CANADA) INC.  
55 St. Clair Avenue West  
Suite 700 Toronto, ON  
M5V 2Y7  
Tel: 416-596-1930

SHEET TITLE

**BLOCK - 1  
SECTION A-A'**

SHEET NUMBER **A.201** ISSUE

SCALE CHECK  
1 in  
75mm



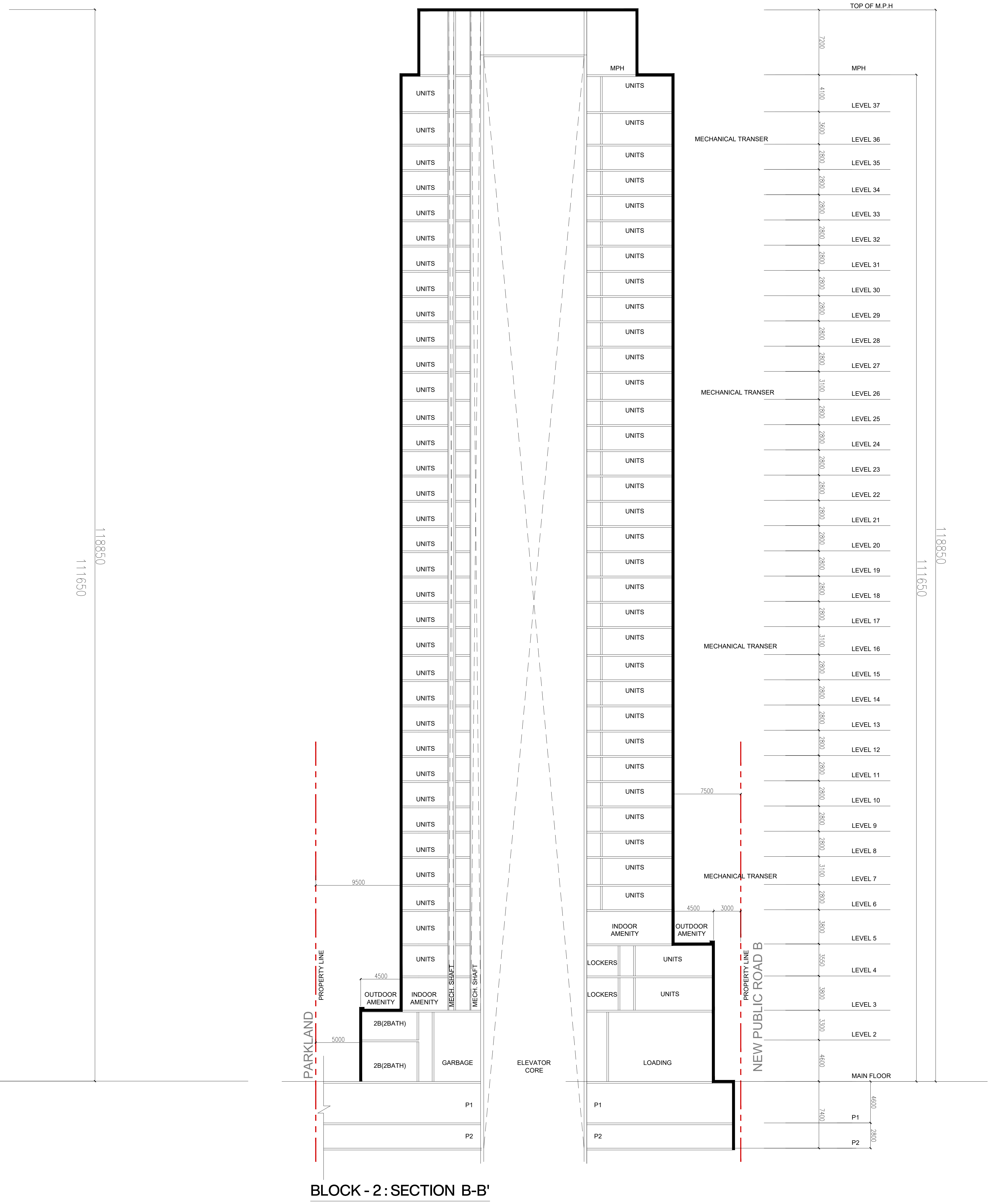

BLOCK - 2 : SECTION B-B'

ISSUES		
No.	DESCRIPTION	DATE
01	REZONING 1 SUBMISSION	2019/12/04
02	REZONING 2 SUBMISSION	2021/10/20
03	SPA SUBMISSION_BLOCK 1 AND 2	2021/12/24
04	REZONING 3 SUBMISSION	2022/10/26
05	REZONING 4 SUBMISSION	2024/02/06



PROJECT  
**670-690  
PROGRESS AVE.**

PROJECT NO: **121606**  
DRAWN BY: DATE: **06 FEB. 2024**  
SCALE: **1:200** APPROVED BY:

**ARCADIS**  
ARCADIS ARCHITECTS (CANADA) INC.  
55 St. Clair Avenue West  
Suite 700 Toronto, ON  
M4V 2Y7  
Tel: 416-596-1930

SHEET TITLE  
**BLOCK - 2  
SECTION A-A' & B-B'**

SHEET NUMBER **A.203** ISSUE

SCALE CHECK  
1:200  
10mm

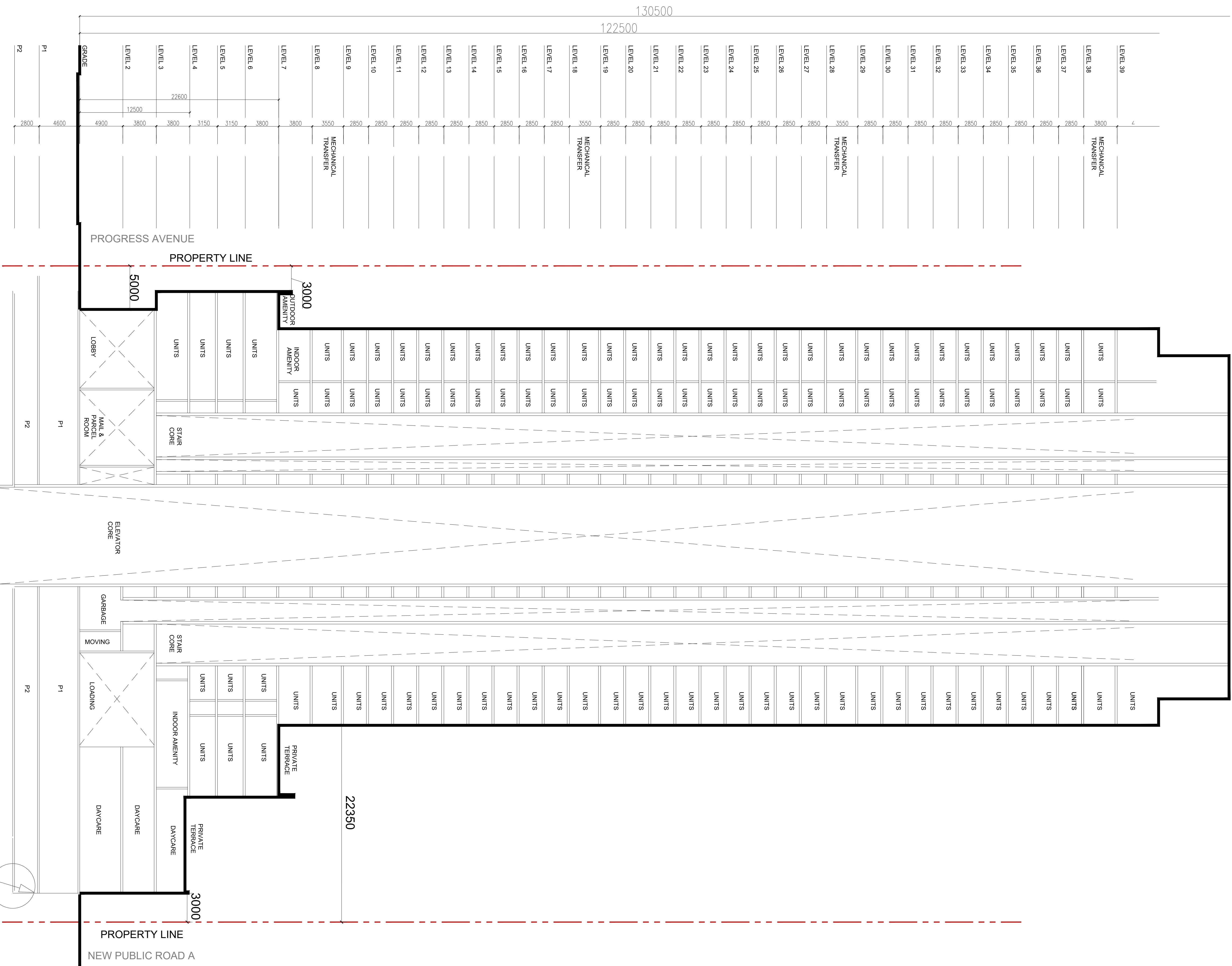

BLOCK - 3 SECTION B-B'

ISSUES	NO.	DESCRIPTION	DATE
01	REZONING 1 SUBMISSION	2019/03/04	
02	REZONING 2 SUBMISSION	2021/10/20	
03	SPM SUBMISSION, BLOCK 1 AND 2	2021/11/24	
04	REZONING 3 SUBMISSION	2022/10/28	
05	REZONING 4 SUBMISSION	2024/02/06	

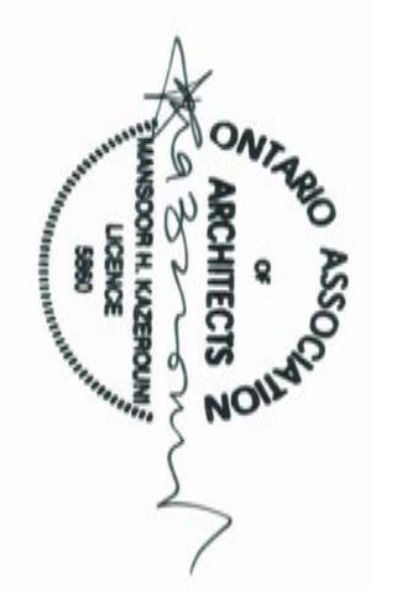

PROJECT  
670-690  
PROGRESS AVE.

PROJECT NO: 121606  
DRAWN BY: DATE: 06 FEB. 2024  
SCALE: APPROVED BY:



SHEET TITLE  
BLOCK - 3  
SECTION A-A' & B-B'

SHEET NUMBER  
A.204

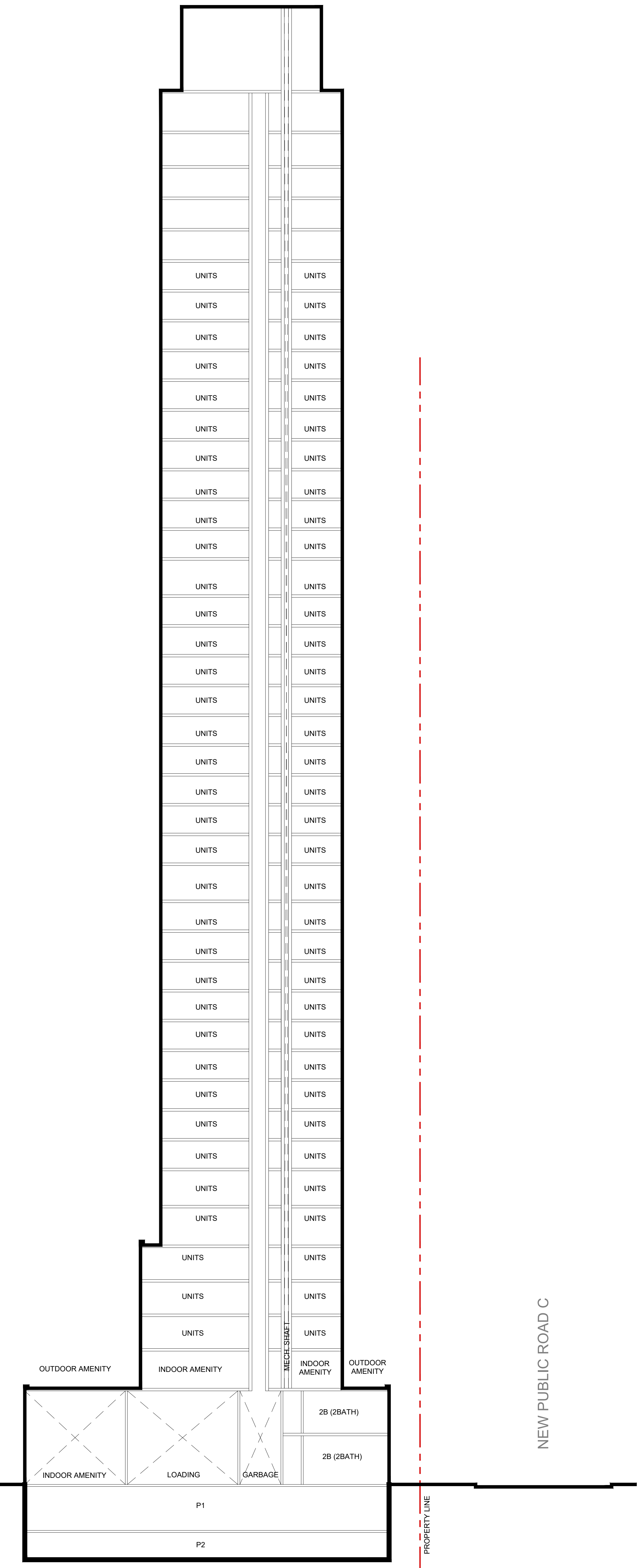
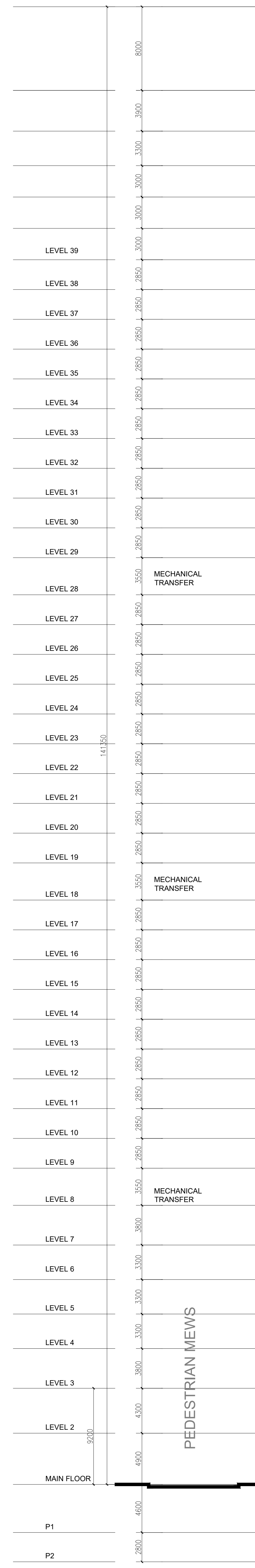
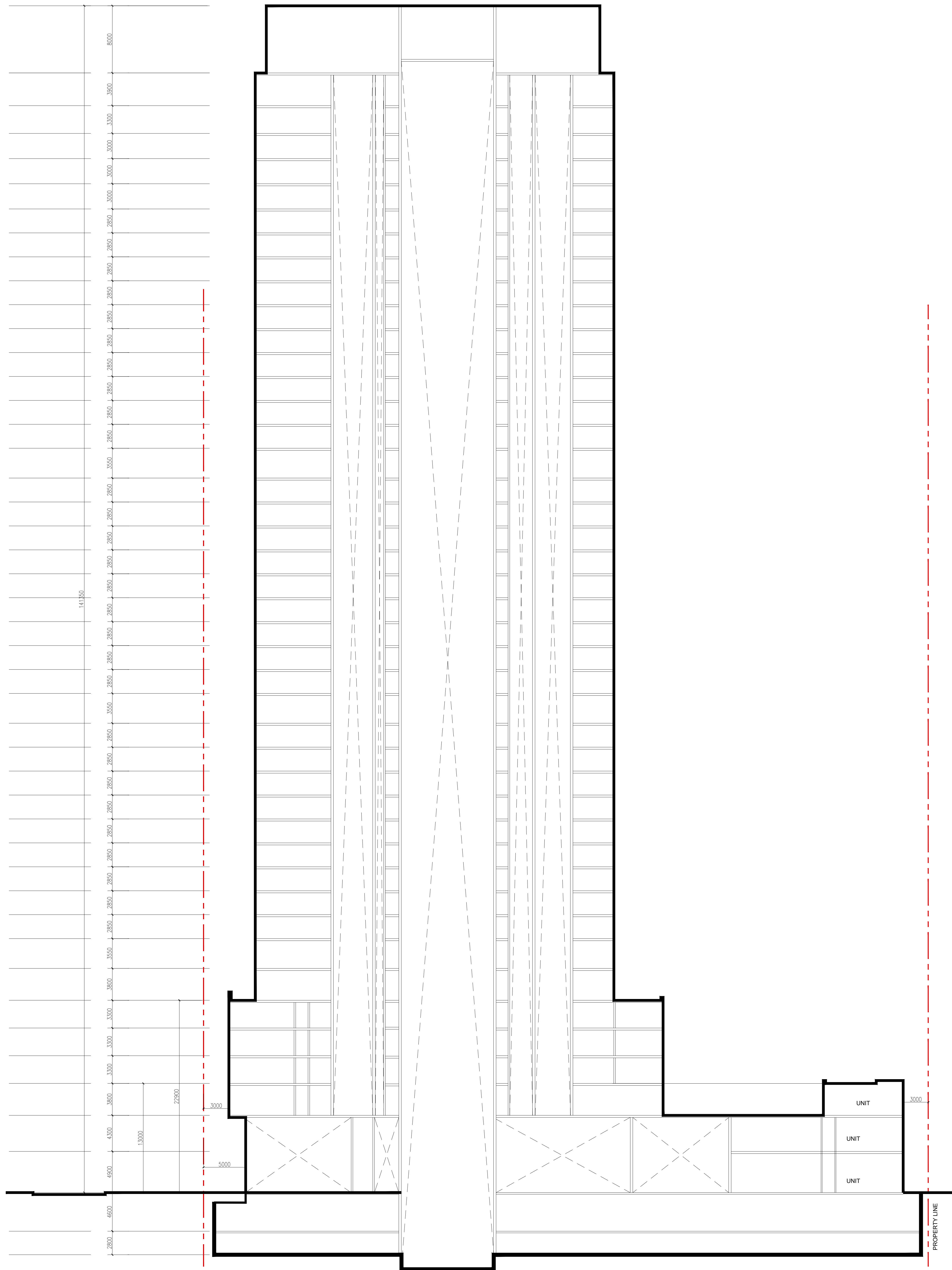

BLOCK - 4: SECTION B-B'

ISSUES

No.	DESCRIPTION	DATE
01	REZONING 1 SUBMISSION	2019/12/04
02	REZONING 2 SUBMISSION	2021/10/20
03	SPA SUBMISSION_BLOCK 1 AND 2	2021/12/24
04	REZONING 3 SUBMISSION	2022/10/26
05	REZONING 4 SUBMISSION	2024/02/06



PROJECT

670-690  
PROGRESS AVE.

PROJECT NO: 121606

DRAWN BY: DATE: 06 FEB. 2024

SCALE: 1:200 APPROVED BY:

**ARCADIS**  
ARCADIS ARCHITECTS (CANADA) INC.  
55 St. Clair Avenue West  
Suite 700 Toronto, ON  
M4V 2Y7  
Tel: 416-596-1930

SHEET TITLE

BLOCK - 4  
SECTION A-A' & B-B'

SHEET NUMBER  
A.205

ISSUE

True North Project North

SCALE CHECK  
1 in 10mm

171.300

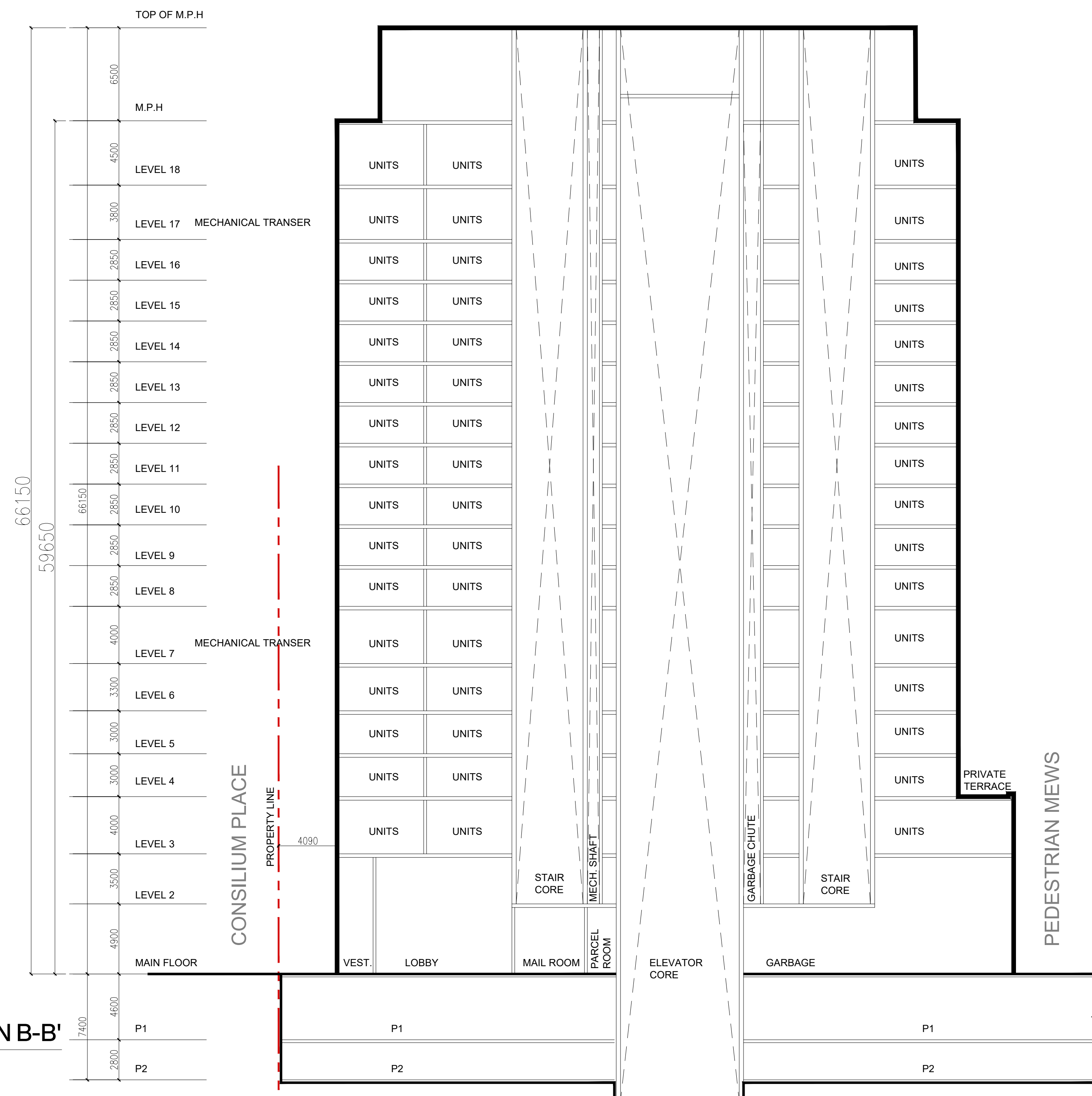

BLOCK - 5: SECTION B-B'

No.	DESCRIPTION	DATE
01	REZONING 1 SUBMISSION	2019/12/04
02	REZONING 2 SUBMISSION	2021/10/20
03	SPA SUBMISSION_BLOCK 1 AND 2	2021/12/24
04	REZONING 3 SUBMISSION	2022/10/26
05	REZONING 4 SUBMISSION	2024/02/06

SEAL



PROJECT

670-690  
PROGRESS AVE.

PROJECT NO:	121606
DRAWN BY:	DATE: 06 FEB. 2024
SCALE:	1:200
	APPROVED BY:

**ARCADIS**  
 ARCADIS ARCHITECTS (CANADA) INC.  
 55, St. Clair Avenue West  
 Suite 700, Toronto, ON  
 M4V 2Y7  
 Tel: 416 596 1930

SHEET TITLE  
**BLOCK - 5  
SECTION A-A' & B-B'**

SHEET NUMBER	ISSUE
<b>A.206</b>	

SCALE CHECK  
1/31

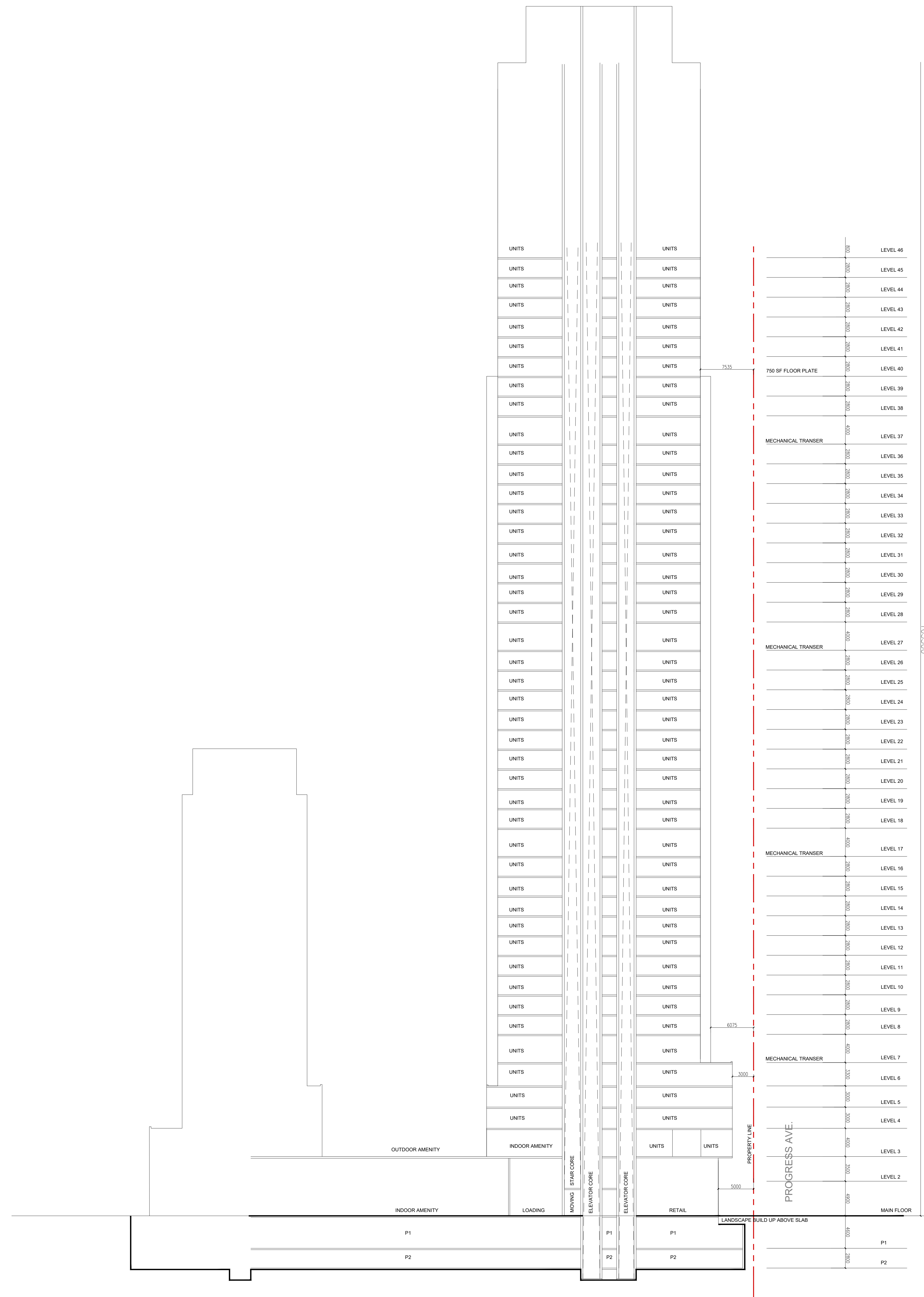

BLOCK - 5  
SECTION C-C'

ISSUES		
No.	DESCRIPTION	DATE
01	REZONING 1 SUBMISSION	2019/12/04
02	REZONING 2 SUBMISSION	2021/10/20
03	SPA SUBMISSION_BLOCK 1 AND 2	2021/12/24
04	REZONING 3 SUBMISSION	2022/10/26
05	REZONING 4 SUBMISSION	2024/02/06

SEAL



PROJECT

670-690  
PROGRESS AVE.

PROJECT NO: 121606

DRAWN BY: DATE: 06 FEB. 2024

SCALE: APPROVED BY:

**ARCADIS**  
ARCADIS ARCHITECTS (CANADA) INC.  
55 St. Clair Avenue West  
Suite 700 Toronto, ON  
M5V 2Y7  
Tel 416 596 1930

SHEET TITLE

BLOCK - 5  
SECTION C-C'

SHEET NUMBER  
A.207

ISSUE

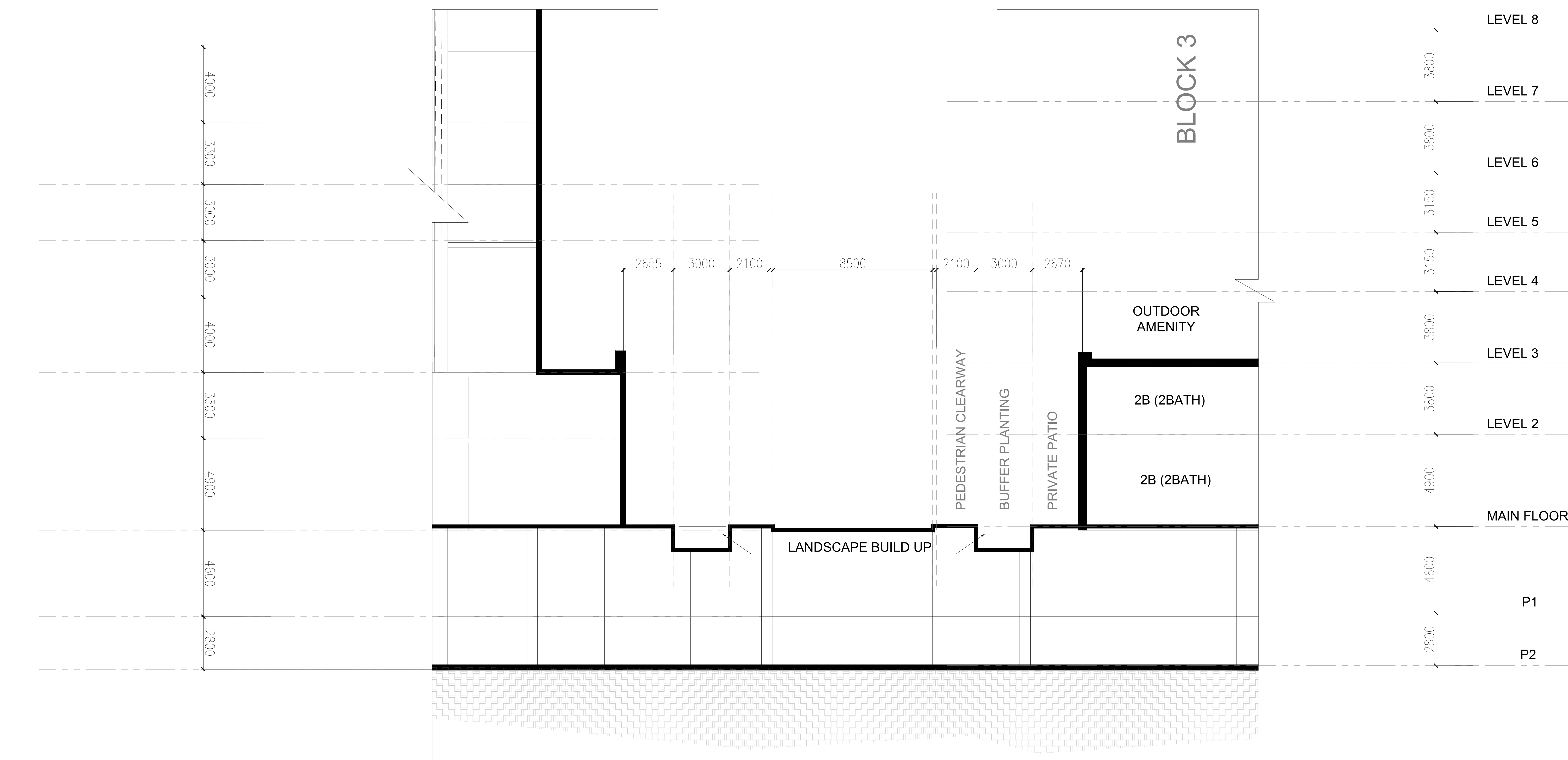
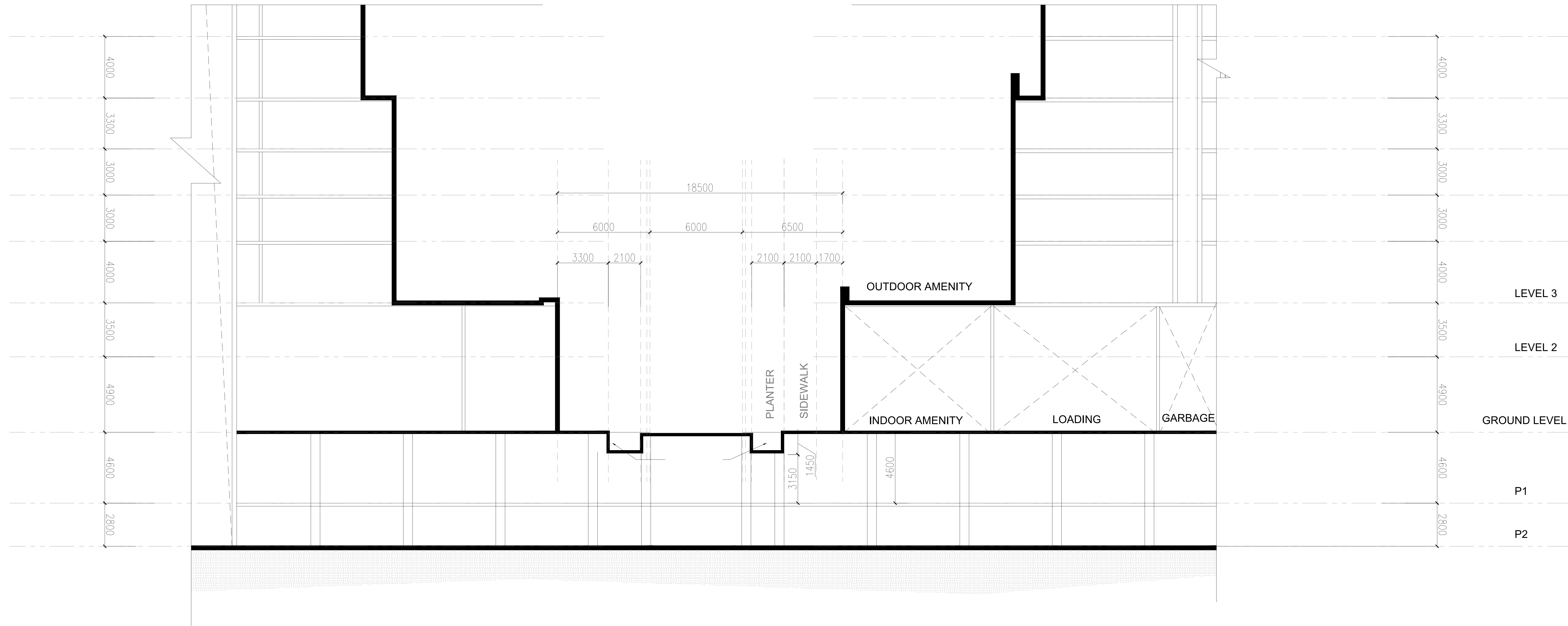

No.	DESCRIPTION	DATE
01	REZONING 1 SUBMISSION	2019/12/04
02	REZONING 2 SUBMISSION	2021/10/20
03	SPA SUBMISSION_BLOCK 1 AND 2	2021/12/24
04	REZONING 3 SUBMISSION	2022/10/26
05	REZONING 4 SUBMISSION	2024/02/06

SEAL



PROJECT

670-690  
PROGRESS AVE.

PROJECT NO: 121606

DRAWN BY: DATE: 06 FEB. 2024  
SCALE: 1:100 APPROVED BY:



SHEET TITLE  
STREET SECTIONS

SHEET NUMBER  
A.208

ISSUE

True North Project North

70mm  
SCALE CHECK  
1 in

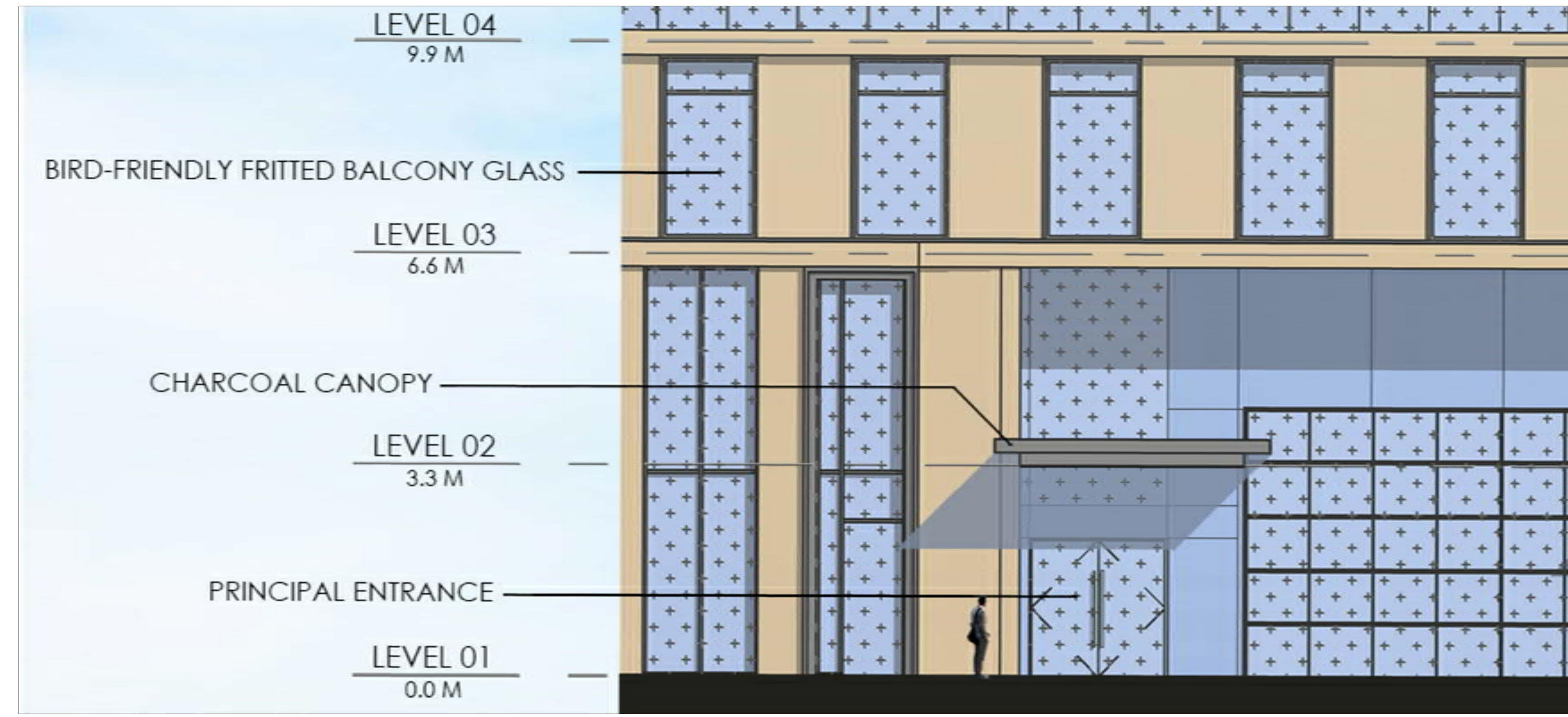
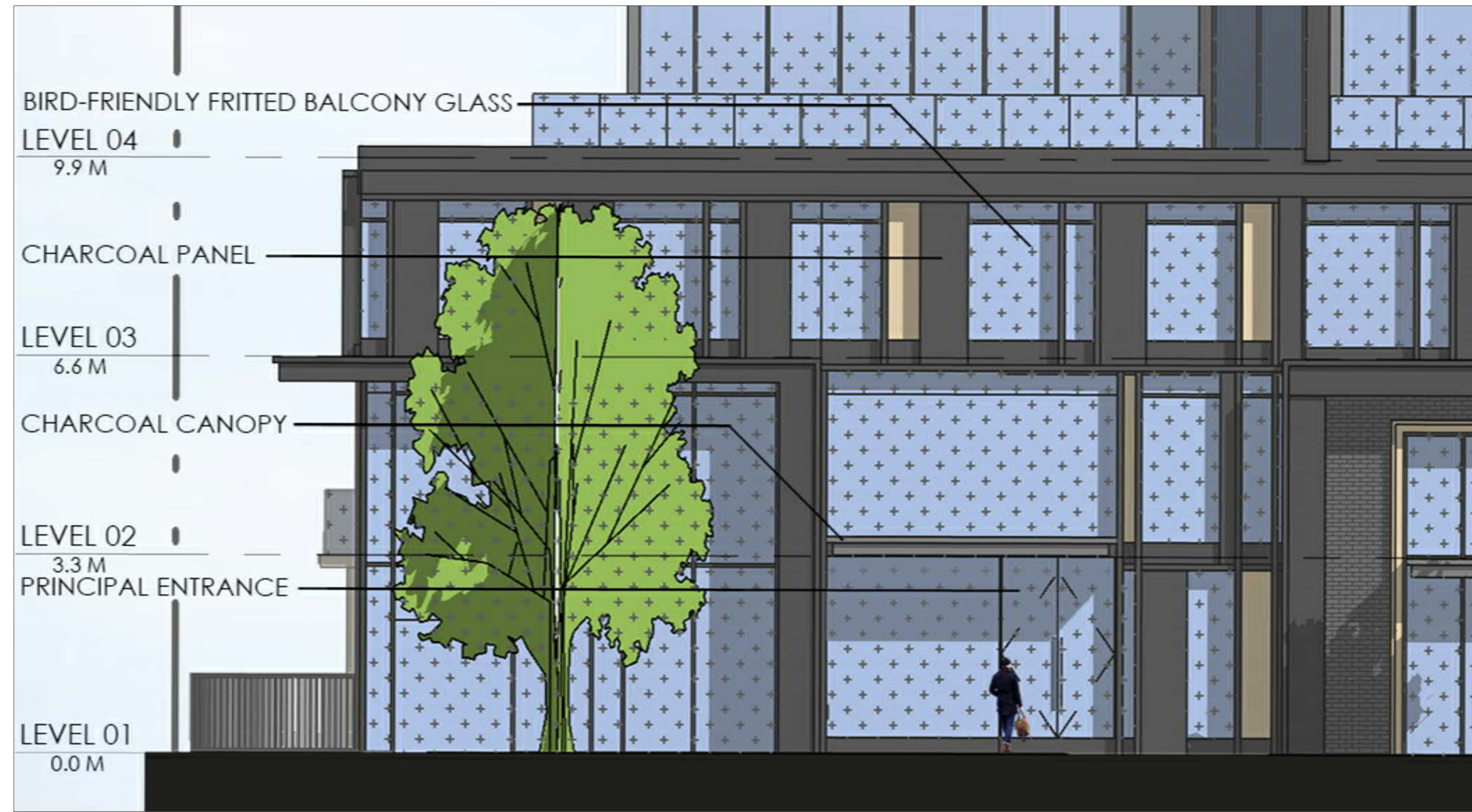

4. BLOCK 4 - MAIN ENTRANCE

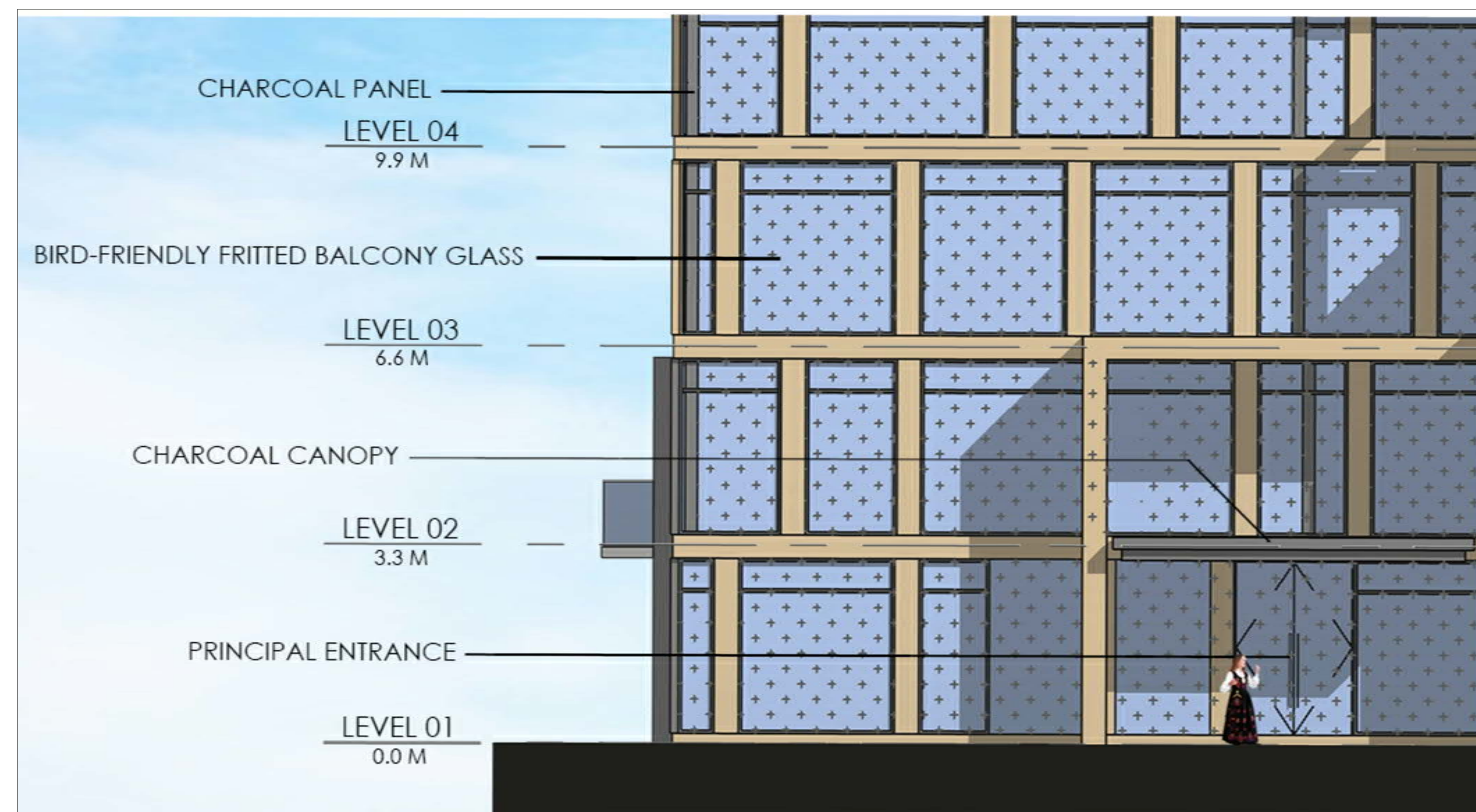
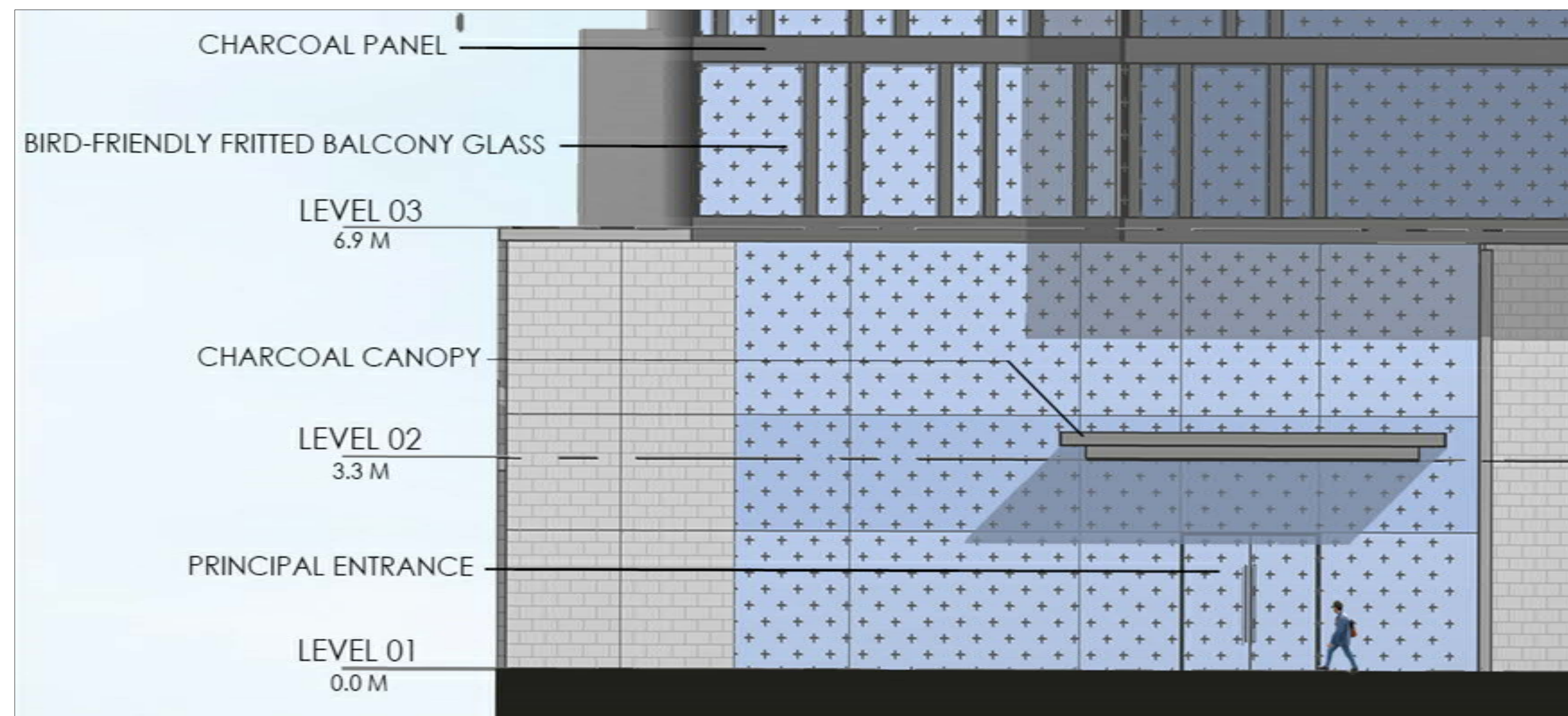

5. BLOCK 5 - MAIN ENTRANCE



ISSUES		
No.	DESCRIPTION	DATE
01	REZONING 1 SUBMISSION	2019/12/04
02	REZONING 2 SUBMISSION	2021/10/20
03	SPA SUBMISSION_BLOCK 1 AND 2	2021/12/24
04	REZONING 3 SUBMISSION	2022/10/26
05	REZONING 4 SUBMISSION	2024/02/06

SEAL



PROJECT

670-690  
PROGRESS AVE.

PROJECT NO: 121606

DRAWN BY: DATE: 06 FEB. 2024  
SCALE: APPROVED BY:

**ARCADIS**  
ARCADIS ARCHITECTS (CANADA) INC.  
55, St. Clair Avenue West  
Suite 703, Toronto, ON  
M4V 2Y7  
Tel 416 596 1930

SHEET TITLE

DETAILED  
ELEVATIONS (1:50)  
MAIN ENTRANCES

SHEET NUMBER  
A.209

ISSUE