

PANEL ELEVATION

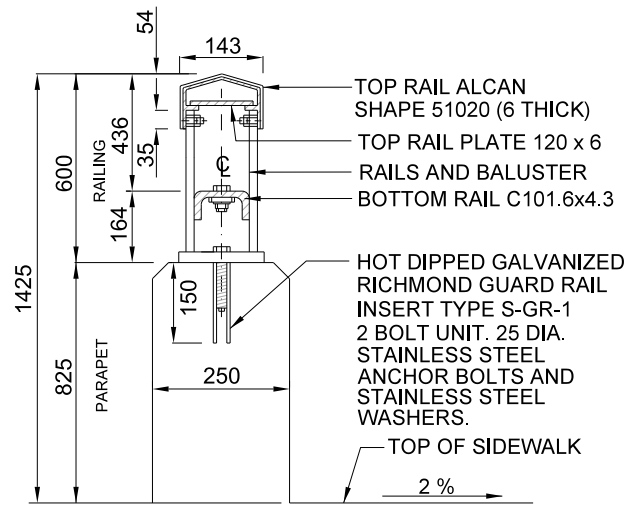

SECTION A - A

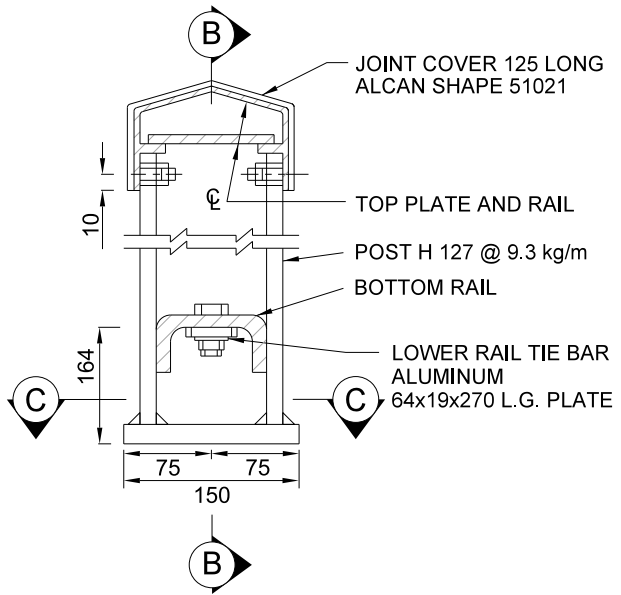

POST DETAIL

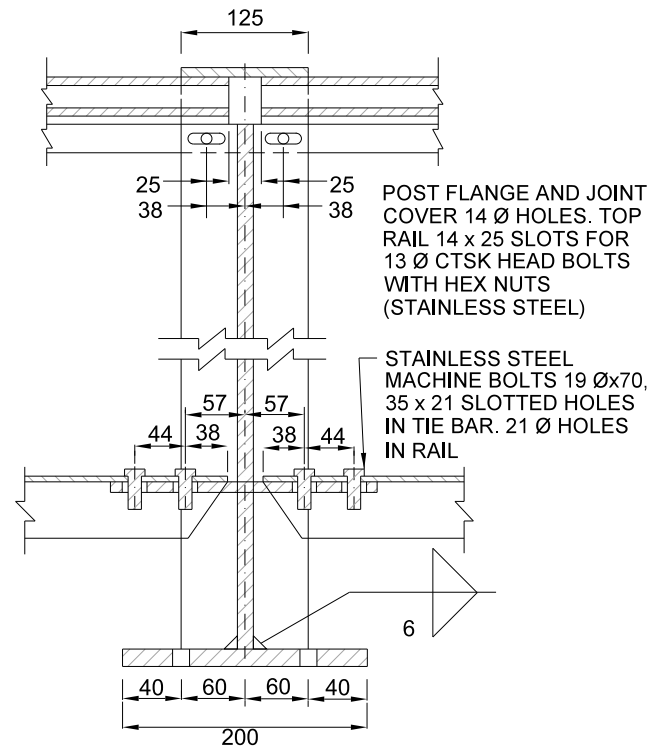

SECTION B - B

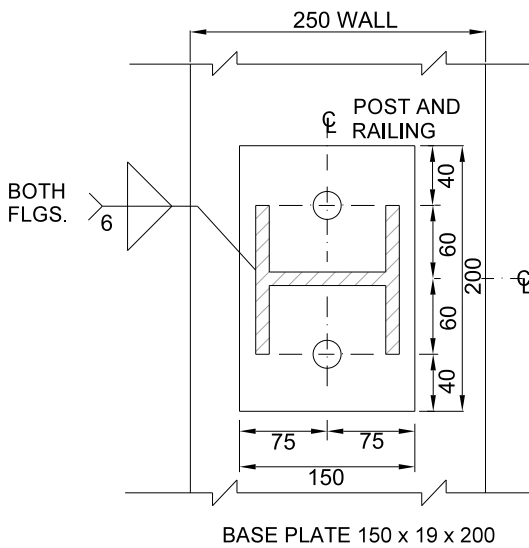

SECTION C - C

NOTES:

1. PAINT BOTTOM OF BASE PLATE WITH ASPHALTIC MASTIC.
2. POST AND BALUSTERS TO BE VERTICAL. TOP AND BOTTOM RAILS TO BE PARALLEL TO TOP OF CONCRETE.

MATERIAL	USE	SPECIFICATION
ALUMINUM - EXTRUDED SHAPES	POST AND RAILS	6351-T6 OR 6061-T6
ALUMINUM - TUBING	BALUSTERS	6351-T6 OR 6061-T6
ALUMINUM - SHEET AND PLATE	TOP BASE AND TIE PLATES	6351-T6 OR 6061-T6
STAINLESS STEEL TYPE 304	BOLTS	ASTM F593
	NUTS AND WASHERS	ASTM F594

All dimensions are in millimetres unless otherwise shown.

ENGINEERING & CONSTRUCTION SERVICES STANDARD DRAWING

REV 4 SEP 2024



**STANDARD ALUMINUM RAILING FOR
SIDEWALKS AND WALLS WITH CONCRETE PARAPETS**

T-900.01-2

NTS SHEET 1